

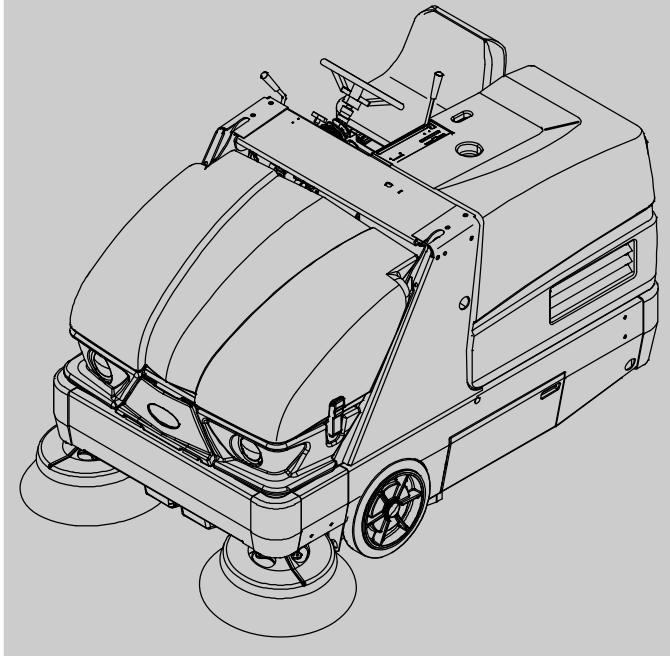

S20

(Battery)



Sweeper Operator Manual



SweepMax™ System
ShakeMax™ 360
Tennant True® Parts
IRIS® a Tennant Technology

North America / International



For the latest Parts manuals and other
language Operator manuals, visit:

www.tennantco.com/manuals

9006704
Rev. 07 (11-2016)



INTRODUCTION

This manual is furnished with each new model. It provides necessary operation and maintenance instructions.



Read this manual completely and understand the machine before operating or servicing it.

This machine will provide excellent service. However, the best results will be obtained at minimum costs if:

- The machine is operated with reasonable care.
- The machine is maintained regularly - per the machine maintenance instructions provided.
- The machine is maintained with manufacturer supplied or equivalent parts.

PROTECT THE ENVIRONMENT	MACHINE DATA
	Please fill out at time of installation for future reference.
Please dispose of packaging materials, used components such as batteries and fluids in an environmentally safe way according to local waste disposal regulations.	Model No. – _____
	Serial No. – _____
Always remember to recycle.	Installation Date – _____

INTENDED USE

The S20 is an industrial rider machine designed to sweep hard surfaces (concrete, asphalt, stone, synthetic, etc). Typical applications include industrial warehouses, manufacturing facilities, distribution facilities, stadiums, arenas, convention centers, parking facilities, transportation terminals, and construction sites. Do not use this machine on soil, grass, artificial turf, or carpeted surfaces. This machine can be used both indoors and outdoors, but ensure there is adequate ventilation if used indoors. This machine is not intended for use on public roadways. Do not use this machine other than described in this Operator Manual.

Tennant Company

PO Box 1452

Minneapolis, MN 55440

Phone: (800) 553-8033 or (763) 513-2850

www.tennantco.com

Thermo-Sentry, Perma-Filter, InstantAccess, Lower Total Cost of Ownership, and Duramer are trademarks of Tennant Company.

Specifications and parts are subject to change without notice.

Original Instructions, Copyright © 2009 – 2012, 2014, 2015, 2016 TENNANT Company, Printed in U.S.A.

CONTENTS

	Page		Page
Important Safety Instructions – Save These		Batteries	37
Instructions	3	Checking The Electrolyte Level	37
Operation	7	Checking Connections / Cleaning	37
Machine Components	7	Charging The Batteries	
Controls And Instruments	8	(Off–Board Charger)	38
Symbol Definitions	19	Fuses , Relays, And Circuitbreakers	40
Installing Batteries	11	Fuses	40
Battery Specifications	11	Relays	40
Operation Of Controls	12	Circuit Breakers	41
Directional Pedal	12	Electric Motors	41
Brake Pedal	12	Belts	42
Parking Brake Pedal	12	Hydraulic Pump Belt	42
Parking Brake Light	12	Vacuum Fan Belt	42
Main Cover Lever	13	Main Brush Intermediate Belt	42
Steering Wheel Tilt Handle	13	Main Brush Belt	42
Main Brush Adjustment Knob	13	Hopper Dust Filter	43
Side Brush Adjustment Knob	13	Replacing The Hopper Dust Filter	43
Clogged Dust Filter Light	14	Cleaning The Hopper Dust Filter	44
Hopper Temperature Light –		Cleaning The Cyclone Assembly	44
Thermo–Sentry	14	Cyclone Dust Tray Seals	44
Hopper Door Closed Light	14	Cyclone Perma–Filter	45
Clogged Hydraulic Filter Light	14	Cyclone Cover Seals	45
Power Kill Switch	15	Hopper Dust Filter Cover Seal	45
Battery Discharge Indicator	15	Main Brush	46
Hour Meter	15	Replacing Or Rotating The Main Brush	46
Operating / Hazard Lights Switch	15	Checking The Main Brush Pattern	47
Operator Seat	16	Adjusting The Main Brush Taper	47
Deluxe Suspension Seat (Option)	16	Adjusting The Main Brush Width	48
Seat Belts (Option)	16	Side Brush(Es)	48
How The Machine Works	17	Replacing The Side Brush	48
Brush Information	17	Adjusting The Side Brush Pattern	49
While Operating The Machine	18	Side Brush Guard	49
Pre–operation Checklist	19	Side Brush Pivot	49
Starting The Machine	20	Skirts, Flaps, And Seals	50
Turning Off The Machine	21	Hopper Lip Skirt	50
Sweeping	22	Hopper Side Skirt	50
Stop Sweeping	23	Brush Door Skirts	50
Emptying The Hopper	24	Rear Skirts	50
Engaging Hopper Support Bar	26	Side Brush Dust Control	
Disengaging Hopper Support Bar	27	Skirts (Option)	51
Options	29	Brush Door Seals	51
Vacuum Wand	29	Hopper Seals	51
Tower Bumpers (Option)	30	Hopper Access Door Seal	51
Machine Troubleshooting	31	Inner Hopper Access Door Seal	
Maintenance	32	(Option – Vacuum Wand Only)	52
Maintenance Chart	32	Hopper Door Seals	52
Lubrication	34	Filter Chamber Inlet Seal	52
Propelling Gearbox	34	Brakes And Tires	53
Rear Wheel Support	34	Brakes	53
Steering Link	34	Tires	53
Front Wheel Bearings	34	Rear Wheel	53
Hopper Lift Arm Pivots	35	Pushing, Towing, And Transporting	
Hydraulics	35	The Machine	54
Hydraulic Fluid Reservoir	35	Pushing Or Towing The Machine	54
Hydraulic Fluid	36	Transporting The Machine	54
Hydraulic Hoses	36	Machine Jacking	55
		Storage Information	55

CONTENTS

	Page
Specifications	56
General Machine Dimensions/Capacities .	56
General Machine Performance	57
Power Type	57
Steering	57
Hydraulic System	59
Braking System	58
Tires	58
Machine Dimensions	58
Index	59

IMPORTANT SAFETY INSTRUCTIONS – SAVE THESE INSTRUCTIONS

The following precautions are used throughout this manual as indicated in their description:

 **WARNING: To warn of hazards or unsafe practices that could result in severe personal injury or death.**

FOR SAFETY: To identify actions that must be followed for safe operation of equipment.

The following information signals potentially dangerous conditions to the operator. Know when these conditions can exist. Locate all safety devices on the machine. Report machine damage or faulty operation immediately.

 **WARNING: Batteries emit hydrogen gas. Explosion or fire can result. Keep sparks and open flame away. Keep covers open when charging.**

 **WARNING: Lift arm pinch point. Stay clear of hopper lift arms.**

 **WARNING: Raised hopper may fall. Engage hopper support bar.**

 **WARNING: Moving belt and fan. Keep away.**

 **WARNING: Machine can emit excessive noise. Hearing loss can result. Wear hearing protection. (Cab option only).**

 **WARNING: Accident may occur. Do not operate vacuum wand while driving. (Vacuum wand option only)**





WARNING: This product contains chemicals known to the state of California to cause cancer, birth defects, or other reproductive harm.

This machine may be equipped with technology that automatically communicates over the cellular network. If this machine will be operated where cell phone use is restricted because of concerns related to equipment interference, please contact a Tennant representative for information on how to disable the cellular communication functionality.

FOR SAFETY:

1. **Do not operate machine:**
 - Unless trained and authorized.
 - Unless operator manual is read and understood.
 - Under the influence of alcohol or drugs.
 - While using a cell phone or other types of electronic devices.
 - Unless mentally and physically capable of following machine instructions.
 - If it is not in proper operating condition.
 - Without filters in place.
 - With brake disabled.
 - In areas where flammable vapors/liquids or combustible dusts are present.
 - In areas that are too dark to safely see the controls or operate the machine unless operating / headlights are turned on.
 - In areas with possible falling objects unless equipped with overhead guard.
2. **Before starting machine:**
 - Check machine for fluid leaks
 - Make sure all safety devices are in place and operate properly.
 - Check brakes and steering for proper operation.
 - Adjust seat and fasten seat belt (if so equipped).
3. **When starting machine:**
 - Keep foot on brake and directional pedal in neutral.
4. **When using machine:**
 - Use only as described in this manual.
 - Do not pick up burning or smoking debris, such as cigarettes, matches or hot ashes
 - Use brakes to stop machine.
 - Go slowly on inclines and slippery surfaces.
 - Do not sweep on ramp inclines that exceed 14% grade or transport (GVWR) on ramp inclines that exceed 17.6% grade.
 - Reduce speed when turning.
 - Keep all parts of body inside operator station while machine is moving.

SAFETY PRECAUTIONS

- Use care when reversing machine.
 - Move machine with care when hopper is raised.
 - Make sure adequate clearance is available before raising hopper.
 - Do not raise hopper when machine is on an incline.
 - Keep children and unauthorized persons away from machine.
 - Do not carry passengers on any part of the machine.
 - Always follow safety and traffic rules.
 - Report machine damage or faulty operation immediately.
5. Before leaving or servicing machine:
- Stop on level surface.
 - Set parking brake.
 - Turn off machine and remove key.
6. When servicing machine:
- All work must be done with sufficient lighting and visibility.
 - Keep work area well ventilated.
 - Avoid moving parts. Do not wear loose clothing, jewelry and secure long hair.
 - Block machine tires before jacking machine up.
 - Do not push or tow the machine on inclines with the brake disabled.
 - Jack machine up at designated locations only. Support machine with jack stands.
 - Use hoist or jack that will support the weight of the machine.
 - Do not push or tow the machine without an operator in the seat controlling the machine.
 - Do not power spray or hose off machine near electrical components.
 - Disconnect battery connections and charger cord before working on machine.
 - Keep all metal objects off batteries.
 - Use a non-conductive battery removal device.
 - Use a hoist and adequate assistance when lifting batteries.
 - Avoid contact with battery acid.
 - Use cardboard to locate leaking hydraulic fluid under pressure.
 - Battery installation must be done by trained personnel.
 - Follow site safety guidelines concerning battery removal.
 - All repairs must be performed by trained personnel.
 - Do not modify the machine from its original design.
- Use Tennant supplied or approved replacement parts.
 - Do not disconnect the off-board charger's DC cord from the machine receptacle when the charger is operating. Arcing may result. If the charger must be interrupted during charging, disconnect the AC power supply cord first.
 - Do not use incompatible battery chargers as this may damage battery packs and potentially cause a fire hazard.
 - Inspect charger cord regularly for damage.
 - Wear personal protective equipment as needed and where recommended in this manual.
-  For Safety: wear hearing protection.
-  For Safety: wear protective gloves.
-  For Safety: wear eye protection.
-  For Safety: wear protective dust mask.
7. When loading/unloading machine onto/off truck or trailer:
- Empty debris hopper before loading machine.
 - Turn off machine and remove key.
 - Use ramp, truck or trailer that will support the weight of the machine and operator.
 - Do not load/unload on ramp inclines that exceed 17.6% grade.
 - Use winch. Do not drive the machine onto/off the truck or trailer unless the load height is 380 mm (15 in) or less from the ground.
 - Set parking brake after machine is loaded.
 - Block machine tires.
 - Tie machine down to truck or trailer.

The following safety labels are mounted on the machine in the locations indicated. If any label becomes damaged or illegible, install a new label in its place.

WARNING LABEL – Lift arm pinch point. Stay clear of hopper lift arms.



Located on both hopper lift arms.

WARNING LABEL – Raised hopper may fall. Engage hopper support pin.

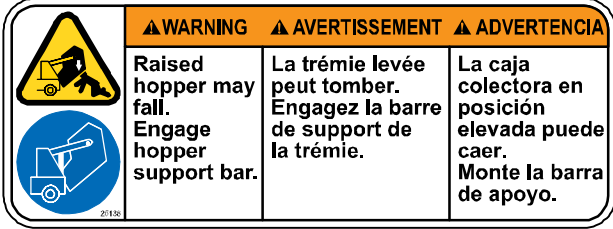

Located on the hopper support bar.

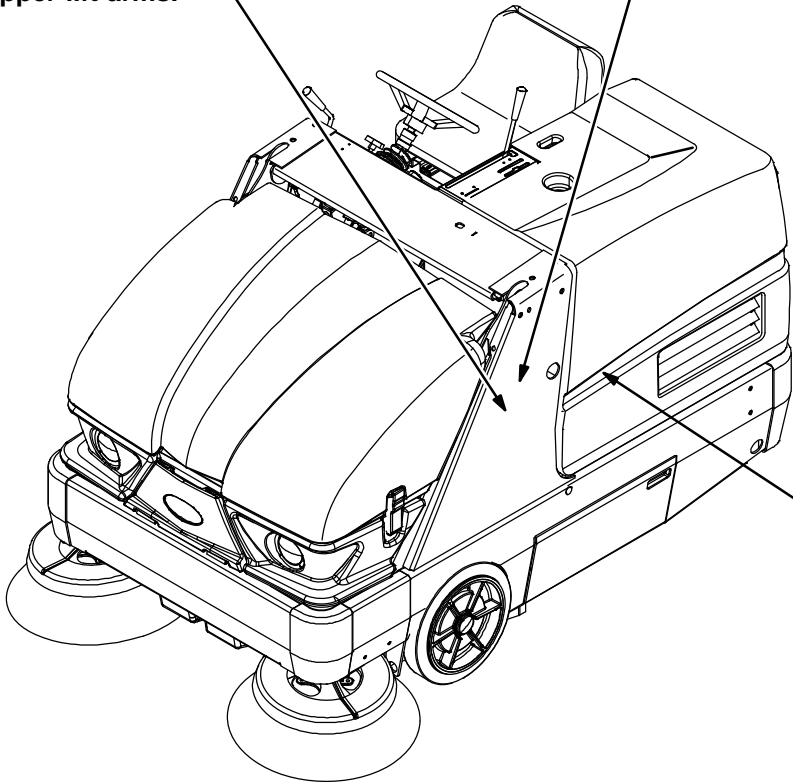

WARNING LABEL – Moving belt and fan. Stay away.

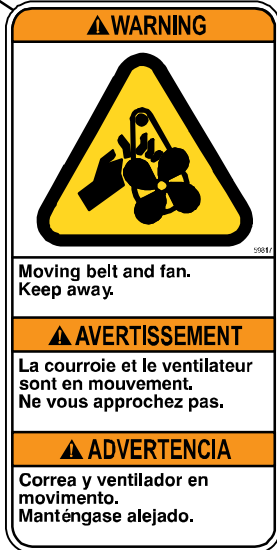

Located on belt guard.

WARNING LABEL – Machine can emit excessive noise. Hearing loss can result. Wear hearing protection.



Located only on machines with cab option.

SAFETY PRECAUTIONS

FOR SAFETY LABEL –
Read manual before
operating machine.



Located on the side of
the operator
compartment.

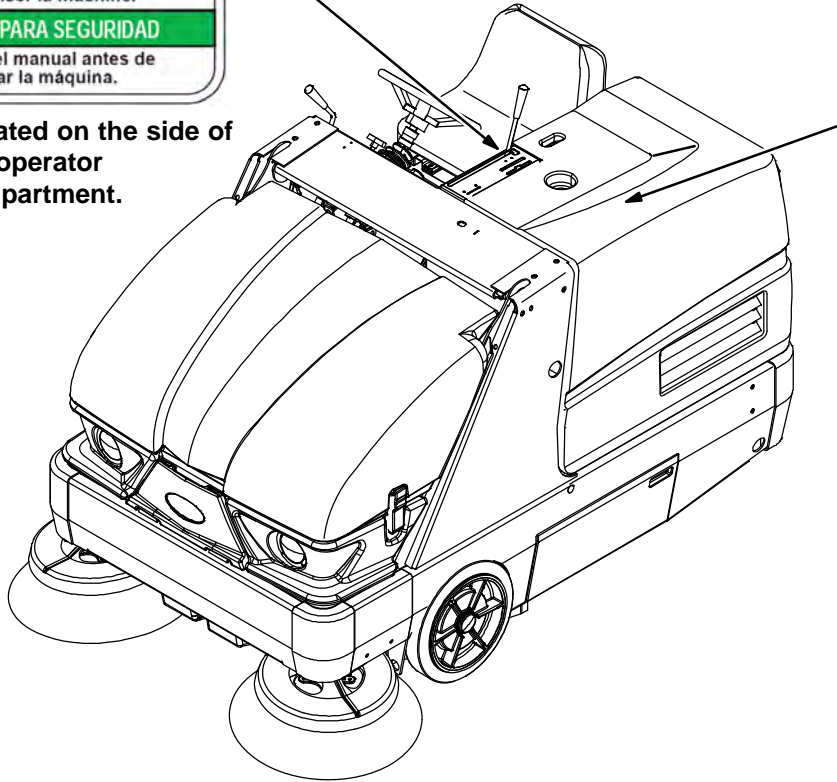

WARNING LABEL – Batteries
emit hydrogen gas. Explosion
or fire can result. Keep sparks
and open flame away. Keep
covers open when charging



Located on back of
main electrical panel.

WARNING LABEL – Accident may occur.
Do not operate vacuum wand
while driving.

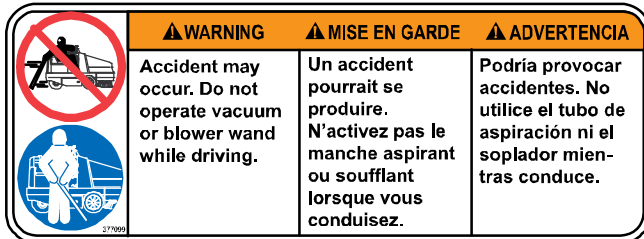

Located on the optional vacuum wand.

354590

OPERATION

MACHINE COMPONENTS



1. Operator seat
2. Steering wheel
3. Instrument panel
4. Hopper cover
5. Side brush

6. Brush door
7. Batteries
8. Hopper access door
9. Main cover

OPERATION

CONTROLS AND INSTRUMENTS

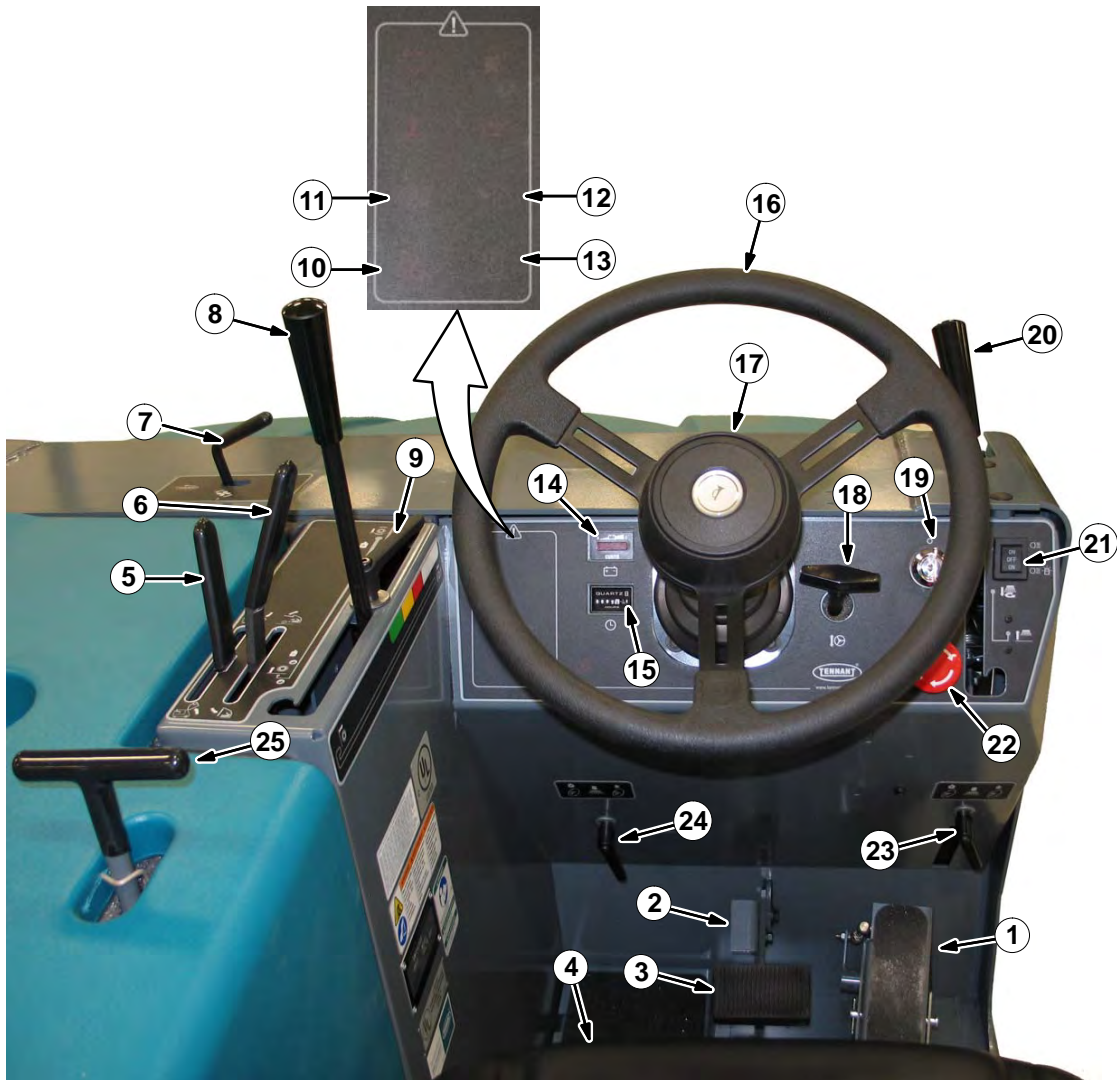

- | | |
|--|---|
| 1. Directional pedal | 14. Battery discharge indicator |
| 2. Parking brake pedal | 15. Hour meter |
| 3. Brake pedal | 16. Steering wheel |
| 4. Seat adjustment lever | 17. Horn button |
| 5. Hopper raise / lower lever | 18. Steering wheel tilt handle |
| 6. Hopper door lever | 19. Key switch |
| 7. Vacuum and filter shaker lever | 20. Side brush lever |
| 8. Main brush lever | 21. Operating / hazard lights switch |
| 9. Main brush adjustment knob | 22. Power kill switch |
| 10. Hopper temperature light – Thermo-Sentry | 23. Right side brush adjustment knob |
| 11. Clogged dust filter light | 24. Left side brush adjustment knob (Dual side brush option only) |
| 12. Hopper door closed light | 25. Main cover lever |
| 13. Clogged hydraulic filter light | |

SYMBOL DEFINITIONS

These symbols identify controls, displays, and features on the machine:



Filter shaker



Vacuum fan on



Vacuum fan off



Hopper down



Hopper up



Hopper door open



Hopper door close (lever)



Main brush down and on



Main brush up and off



Battery charging system

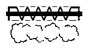

Clogged dust filter



Thermo-Sentry



Hopper door closed (light)



Hour meter



Steering wheel tilt



Off



On



Start



Horn



Side brush down and on



Side brush up and off



Operating lights



Hazard light



Side brush pressure



Parking brake



Clogged hydraulic filter

OPERATION



Brush pressure (Increase)



Brush pressure (Decrease)



Turn counterclockwise



Turn clockwise

1

Circuit breaker #1

2

Circuit breaker #2

3

Circuit breaker #3

4

Circuit breaker #4

5

Circuit breaker #5

6

Circuit breaker #6

7

Circuit breaker #7

8

Circuit breaker #8

9

Circuit breaker #9

10

Circuit breaker #10

11

Circuit breaker #11

12

Circuit breaker #12

13

Circuit breaker #13

14

Circuit breaker #14

15

Circuit breaker #15

16

Circuit breaker #16

17

Circuit breaker #17

18

Circuit breaker #18

19

Circuit breaker #19

INSTALLING BATTERIES

FOR SAFETY: When servicing machine: Keep all metal objects off batteries. Use a non-conductive battery removal device. Use a hoist and adequate assistance when lifting batteries. Battery installation must be done by trained personnel. Follow site safety guidelines concerning battery removal.

BATTERY SPECIFICATIONS

Six 6-volt deep cycle lead acid batteries or 2 18-volt batteries.

Maximum battery dimensions: 178 mm (7 in) W x 297 mm (11.7 in) L x 424 mm (16.7 in) H or 282 mm (11.1 in) W x 485 (19.1 in) L x 590 mm (23.25 in) H.

1. Park the machine on a level surface and remove the key.
2. Open the main cover
3. With adequate assistance carefully install the batteries into the battery compartment tray and arrange the battery posts as shown.

NOTE: For large traction batteries, use a hoist to install the battery.

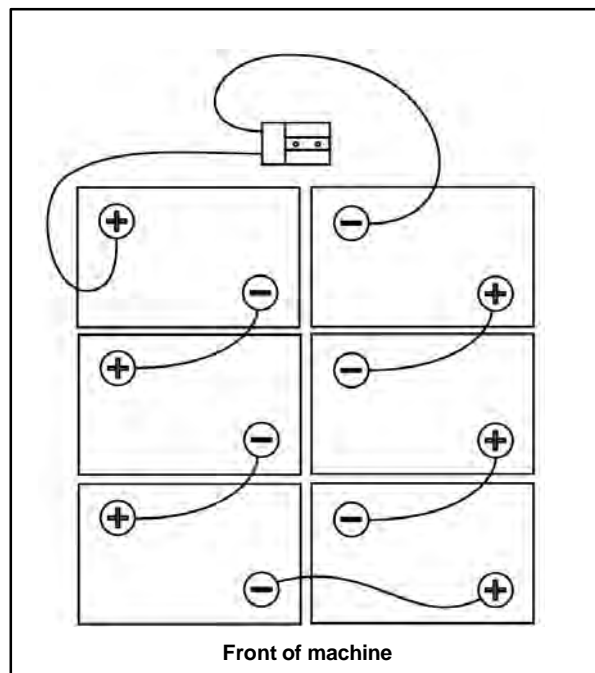

4. Using the supplied battery post boots, connect the cables to the battery posts, RED TO POSITIVE (+) & BLACK TO NEGATIVE (-).

IMPORTANT: Before charging, make sure that the charger setting is properly set for the battery type.

OPERATION

OPERATION OF CONTROLS

DIRECTIONAL PEDAL

Press the top of the *Directional pedal* to move forward and the bottom of the pedal to move backward. The pedal returns to the neutral position when it is released.



BRAKE PEDAL

Press the *Brake pedal* to stop the machine.

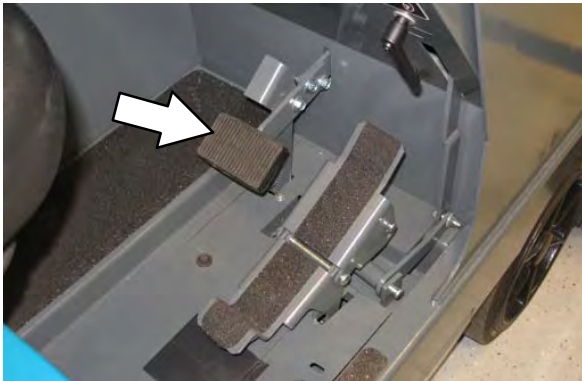

PARKING BRAKE PEDAL

Press the *Brake pedal* down as far as possible and use toe to lock the *Parking brake pedal* into place. Press the *Brake pedal* to release the parking brake. The *Parking brake pedal* will return to the unlocked position.

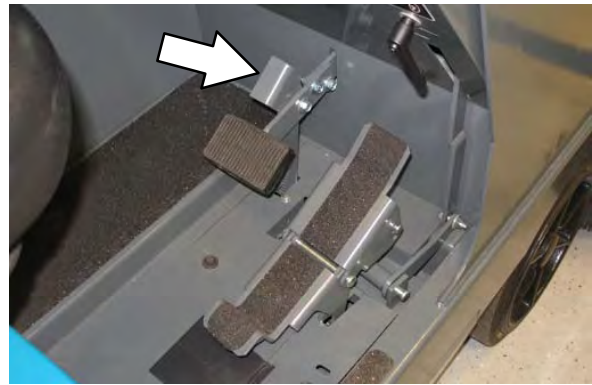

PARKING BRAKE LIGHT

The parking brake light comes on when the parking brake is engaged. Release the parking brake before operating the machine.

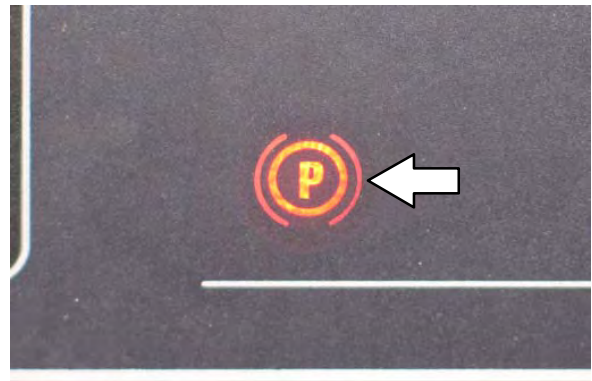

MAIN COVER LEVER

The main cover lever releases and locks the seat support.

Release: Pull the lever back and lift the main cover.

Lock: Close the main cover and release the lever to lock the cover in place.

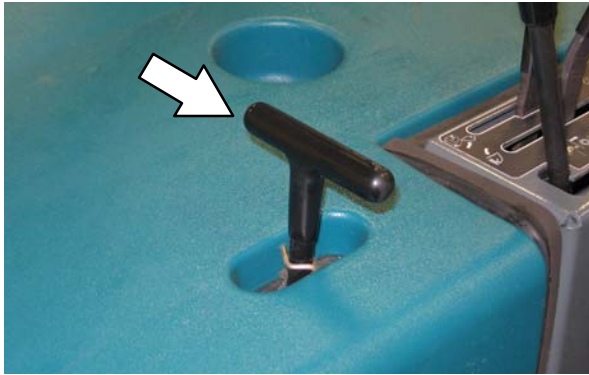

STEERING WHEEL TILT HANDLE

The steering wheel tilt handle controls the angle of the steering wheel.

Adjust: Pull out the tilt handle, move the steering wheel up or down, and release the tilt handle.

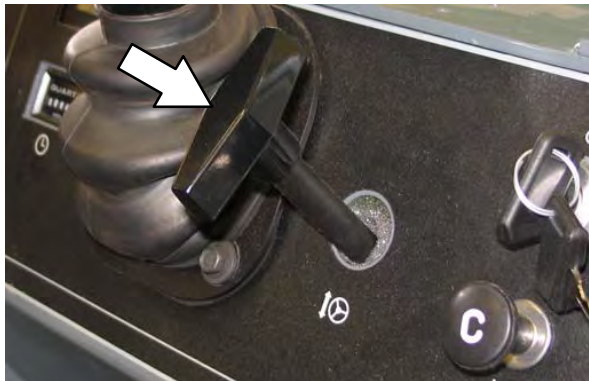

MAIN BRUSH ADJUSTMENT KNOB

The main brush adjustment knob changes the amount of contact the main brush has with the surface being swept. Refer to *ADJUSTING THE MAIN BRUSH WIDTH* section of this manual.

NOTE: The main brush adjustment knob can be repositioned if it interferes with any of the controls. Lift the knob, turn it to the desired position, and release it.



SIDE BRUSH ADJUSTMENT KNOB

The side brush adjustment knob changes the amount of contact the side brush has with the surface being swept. Refer to *ADJUSTING THE SIDE BRUSH PATTERN* section of this manual.

NOTE: The side brush adjustment knob can be repositioned. Lift the knob, turn it to the desired position, and release it.



OPERATION

CLOGGED DUST FILTER LIGHT

The clogged dust filter light comes on when the hopper dust filter is clogged.

To clean the filter, hold the vacuum and filter shaker lever in the **Filter shaker** position. If the clogged filter light remains lit, manually clean the hopper dust filter. See *HOPPER DUST FILTER* in the *MAINTENANCE* section of this manual.

NOTE: The clogged dust filter light also comes on when the hopper door is closed and the vacuum fan is on.

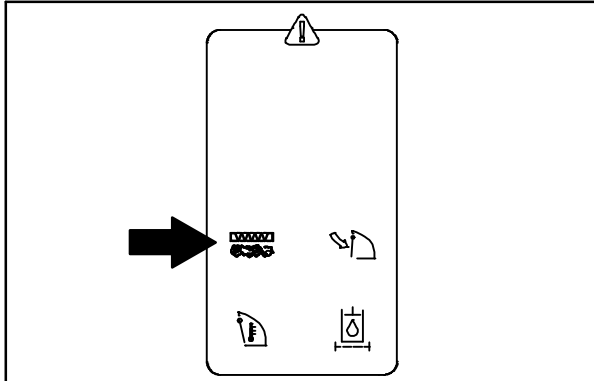

HOPPER TEMPERATURE LIGHT - THERMO-SENTRY

The hopper temperature light comes on when the Thermo-Sentry senses that there is excessive heat in the hopper, possibly from a fire. The Thermo-Sentry will also move the vacuum and filter shaker lever to the **Vacuum fan off** position. If this happens, stop the machine, eliminate the source of the heat, and return the lever to the **Vacuum fan on** position.

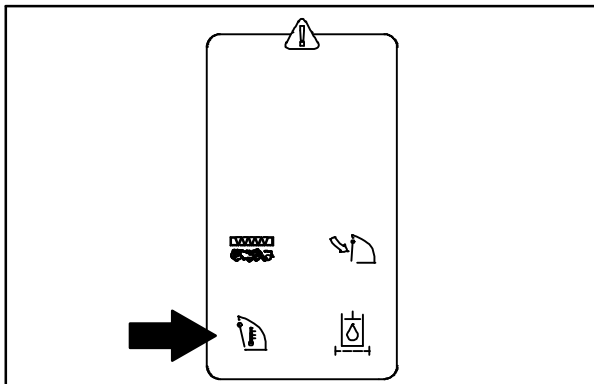

HOPPER DOOR CLOSED LIGHT

The hopper door closed light comes on when the hopper door is closed.

Make sure the hopper door is open all the way and the hopper door closed light is off, before sweeping.

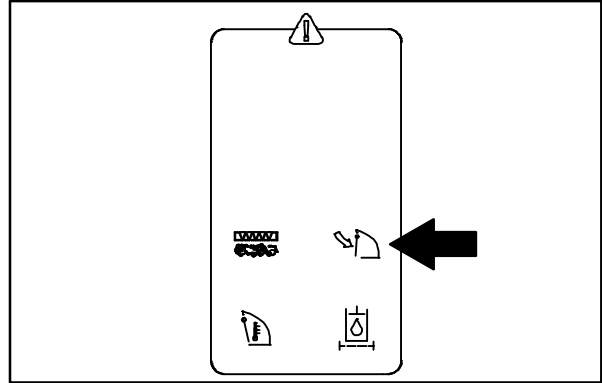

CLOGGED HYDRAULIC FILTER LIGHT

The clogged hydraulic filter light comes on when the hydraulic filter is clogged. If this light remains on, have the hydraulic filter changed as soon as possible.

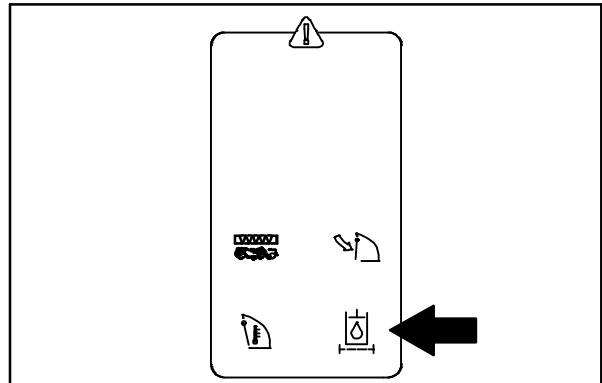

POWER KILL SWITCH

The power kill switch halts all power to the machine.

Halt: Push the power kill switch in.

Restart: Turn off the machine. Turn the power kill switch to the right to release the switch. Turn on the machine.



BATTERY DISCHARGE INDICATOR

The battery discharge indicator shows the charge level of the batteries. It displays the charge level when the machine is operating.

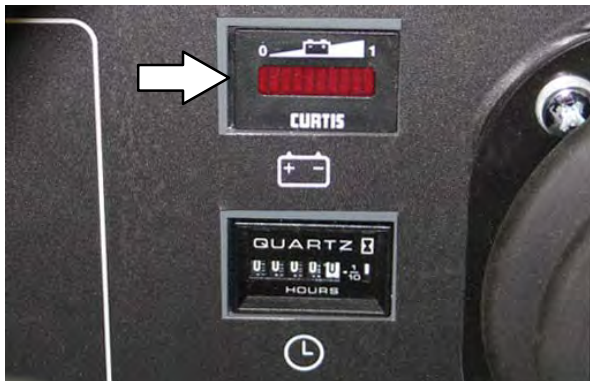

When the batteries are fully charged, the indicator on the far right is lit. As the batteries discharge, the indicator will move along the display to the left. Recharge the batteries when the indicator flashes.

NOTE: The reading on the battery discharge indicator is not accurate when the machine is first powered on. Operate the machine a few minutes before reading the charge level of the batteries.

NOTE: The battery discharge indicator will not reset from the flashing indicator unless the batteries have been fully charged.

HOUR METER

The *Hour meter* records the hours the machine was operated. Use this information to determine machine service intervals.

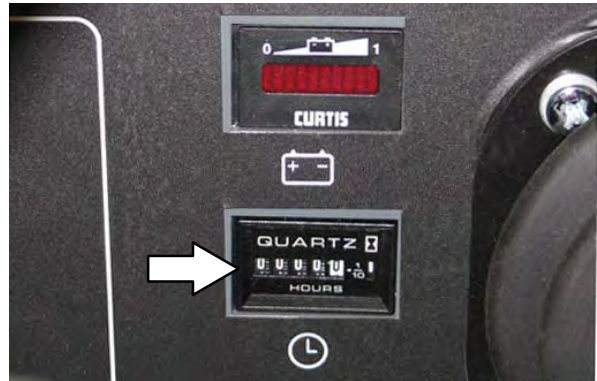

OPERATING / HAZARD LIGHTS SWITCH

The operating / hazard lights switch powers on and off the headlights and taillights and the optional hazard light.

Operating lights on: Press the top part of the switch.

Operating / Hazard lights on (Optional): Press the bottom part of the switch.

Off: Place the switch in the middle position.



OPERATION

OPERATOR SEAT

The front-to-back adjustment lever adjusts the seat position.



The backrest adjustment knob adjusts the angle of the backrest.



DELUXE SUSPENSION SEAT (OPTION)

The operator seat has three adjustments: backrest angle, operator weight, and front to back.

The operator's weight adjustment lever controls the seat weight adjustment. The lever has three positions: lightweight, middleweight, and heavyweight.



The front-to-back adjustment lever adjusts the seat position.



SEAT BELTS (OPTION)

FOR SAFETY: Before starting machine, adjust seat and fasten seat belt (if equipped).



HOW THE MACHINE WORKS



The steering wheel controls the direction of machine travel. The directional pedal controls the speed and forward/reverse direction. The brake pedal slows and stops the machine.

The side brush sweeps debris into the path of the main brush. The main brush sweeps debris from the floor into the hopper. The vacuum system pulls dust and air through the hopper and the dust control system.

When sweeping is finished, shake the dust filter and empty the hopper.

BRUSH INFORMATION

For best results, use the correct brush type for the cleaning application.

NOTE: The amount and type of soilage play an important role in determining the type of brushes to use. Contact a Tennant representative for specific recommendations.

Polypropylene Sand Wedge Main Brush – Recommended for heavy accumulation of sand and other fine particles.

Polypropylene Window Main Brush – Recommended for light litter, especially on smooth floors.

Polypropylene 8-double row Main Brush – Recommended for general sweeping applications.

Polypropylene and Wire 8-double row Main Brush – Recommended for general sweeping and slightly impacted debris.

Polyester 8-double row Main Brush – Recommended for general sweeping, especially on rough or irregular surfaces. Nylon has a long wear life.

Polyester Full Fill Main Brush – Recommended for accumulation of sand and other fine particles. Nylon has a long wear life.

Natural Fiber 8-double row Main Brush – Recommended for accumulation of sand and other very fine particles.

Polypropylene Side Brush – Recommended for general sweeping of light to medium debris.

Nylon Side Brush – Recommended for general sweeping of rough or irregular surfaces. Nylon has a long wear life.

Flat Wire Side Brush – Recommended for outdoor curb-side sweeping where dirt is heavy or compacted.

WHILE OPERATING THE MACHINE

Pick up oversized debris before sweeping. Pick up wire, string, twine, large pieces of wood, or any other debris that could become wrapped around or tangled in the brushes.

NOTE: Debris can be placed in the hopper through the hopper access door on the front of the hopper.

Drive as straight a path as possible. Avoid bumping into posts or scraping the sides of the machine. Overlap the sweep paths by several centimeters (a few inches).

Avoid turning the steering wheel too sharply when the machine is in motion. The machine is very responsive to the movement of the steering wheel. Avoid sudden turns, except in emergencies.

Adjust the machine speed and brush pressure. Use the lowest brush pressure for best performance.

Keep the machine moving to prevent damaging floor finishes.

If poor cleaning performance is observed, stop cleaning and refer to *MACHINE TROUBLESHOOTING* in this manual.

Perform the Daily Maintenance Procedures after each use (see *MACHINE MAINTENANCE* in this manual).

Drive the machine slowly on inclines. Use the brake pedal to control machine speed on descending inclines. Sweep with the machine up inclines rather than down inclines.

FOR SAFETY: When using machine, go slowly on inclines and slippery surfaces. Do not sweep on ramp inclines that exceed 14% grade or transport (GVWR) on ramp inclines that exceed 17.6% grade.

Do not operate machine in areas where the ambient temperature is above 43° C (110° F). Do not operate sweeping functions in areas where the ambient temperature is below freezing 0° C (32° F).

PRE-OPERATION CHECKLIST

- Check the machine for fluid leaks.
- Check the main sweep brush for damage and wear . Remove string, banding, plastic wrap, or other debris wrapped around the brush.
- Check the main brush compartment right skirt for damage and wear.
- Check the side brush(es) for damage and wear . Remove string, banding, plastic wrap, or other debris wrapped around the brush.
- Check the main brush compartment left skirt for damage and wear.
- Check the hydraulic fluid level.
- Check the battery electrolyte level.
- Check for rubbing hoses or wires and leaks or obstructions.
- Check the horn, headlights, taillights, safety lights, and backup alarm (if equipped).
- Check all controls for proper operation.
- Check the hopper skirts and seals for damage and wear.
- Check the brakes and steering for proper operation.
- Check the service records to determine maintenance requirements.

OPERATION

STARTING THE MACHINE

1. Sit in the operator's seat and engage the brakes with the directional pedal in neutral.

FOR SAFETY: When starting machine, keep foot on brake and directional pedal in neutral.

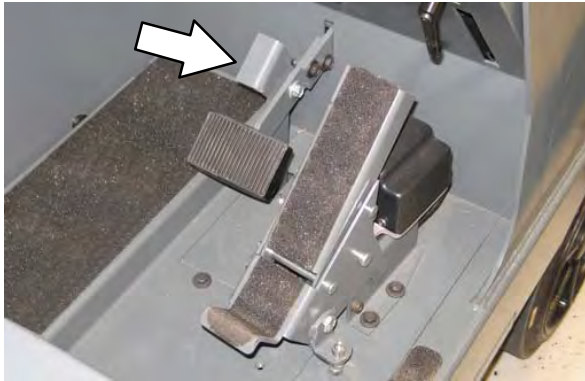

2. Turn on the machine.



3. Release the machine parking brake.

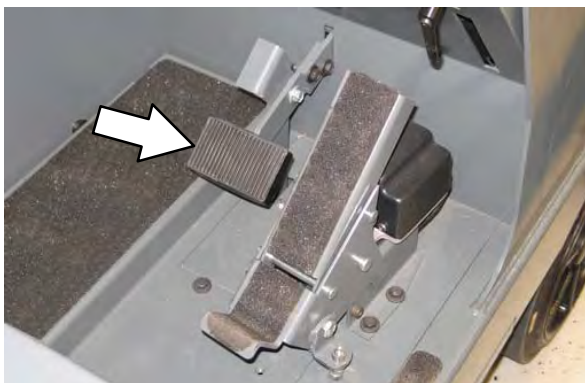

4. Drive the machine to the area to be cleaned.

TURNING OFF THE MACHINE

1. Stop sweeping.
2. Take your foot off the directional pedal. Step on the brake pedal.

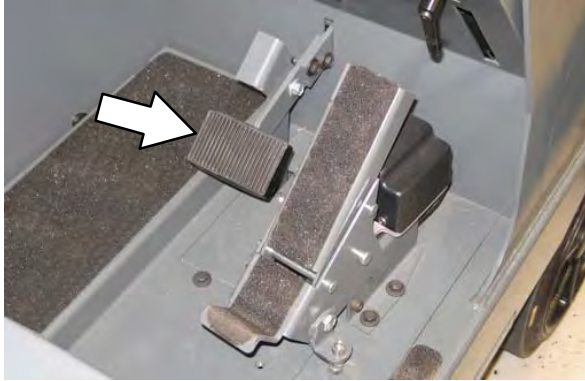

NOTE: The machine will coast for a short distance when your foot is removed from the directional pedal. Use the brake pedal to stop the machine.

3. Set the machine parking brake.

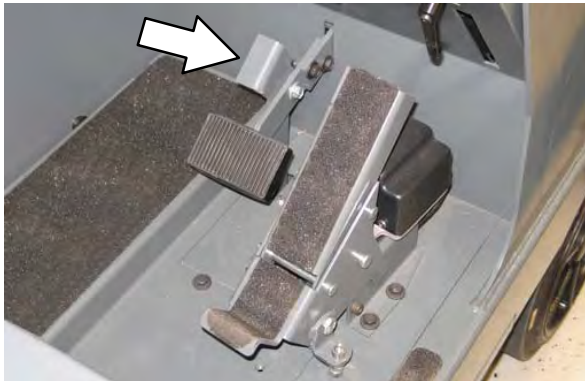

4. Shut the machine off. Remove the key.



FOR SAFETY: Before leaving or servicing machine, stop on level surface, set parking brake, turn off machine, and remove key.

OPERATION

SWEEPING

1. Ensure that the hopper is completely lowered.
2. Push the hopper door lever forward to open the hopper door.



3. Move the vacuum and filter shaker lever to the **Vacuum fan on** position.



NOTE: The vacuum fan duct should be off when sweeping wet debris.

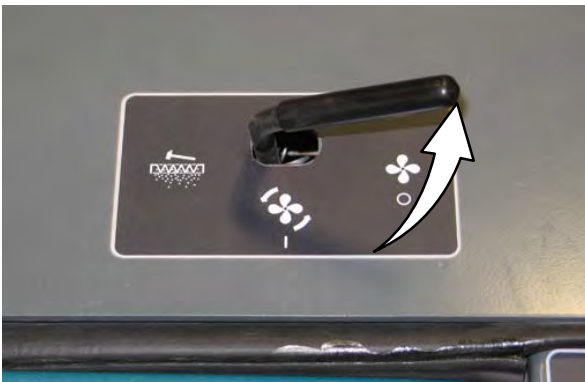

*NOTE: Excessive heat in the hopper will cause the Thermo Sentry to move the vacuum and filter shaker lever to the **Vacuum fan off** position. It will also make the hopper temperature light come on. If this happens, stop the machine, eliminate the source of the heat, and return the lever to the **Vacuum fan on** position.*

4. Place the main brush lever in the right **Main brush down and on** position. The brush will automatically start rotating.



5. Place the side brush lever in the left **Side brush down and on** position. The brush will automatically start rotating.



6. Sweep as needed.

STOP SWEEPING

1. Place the side brush lever in the right **Side brush up and off** position.



2. Place the main brush lever in the left **Main brush up and off** position.



3. Pull and hold the hopper door lever back until the hopper door closed light comes on.



4. Shake the dust filter by holding the vacuum and filter shaker lever in the **Filter shaker** position for 30 seconds.



OPERATION

EMPTYING THE HOPPER

1. Stop sweeping and shake the filter.
2. Pull and hold the hopper door lever back until the hopper door closed light comes on.



3. Slowly drive the machine to the debris site or debris container.
4. Pull and hold the hopper raise / lower lever back and raise the hopper to the desired height. Release the lever into the **Hold** position.



FOR SAFETY: When using machine, do not raise hopper when machine is on an incline. Make sure adequate clearance is available before raising hopper.

NOTE: Be aware that the minimum ceiling height needed to high dump the hopper is 2490 mm (98 in).

5. Drive the machine up to the debris container. Position the hopper over the debris container.

FOR SAFETY: When using machine, move machine with care if hopper is raised.

6. Move the vacuum and filter shaker lever into the **Vacuum fan off** position.



7. Push the hopper door lever forward to empty the hopper.



8. Pull and hold the hopper door lever back until the hopper door closed light comes on.



11. Push the hopper door lever forward to open the hopper door.



9. Slowly back the machine away from the debris site or debris container.

FOR SAFETY: When using machine, use care when reversing machine.

10. Push and hold the hopper raise / lower lever forward to lower the hopper. Release the lever into the **Hold** position.



12. Move the vacuum and filter shaker lever into the **Vacuum fan on** position.



OPERATION

ENGAGING HOPPER SUPPORT BAR

1. Set the machine parking brake.

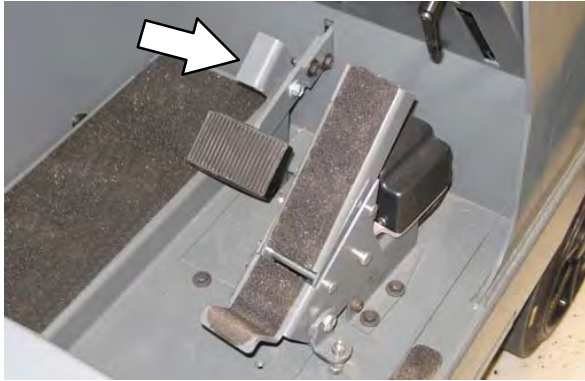

FOR SAFETY: When starting machine, keep foot on brake and directional pedal in neutral.

2. Turn on the machine.



3. Pull and hold the hopper lever back into the **Hopper up** position to raise the hopper. Release the hopper lever into the **Hold** position.

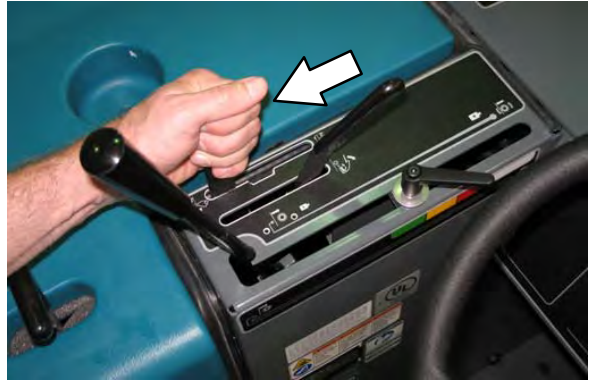

FOR SAFETY: When using machine, make sure adequate clearance is available before raising hopper.

NOTE: Be aware that the minimum ceiling height needed to high dump the hopper is 2490 mm (98 in).

4. Lower and position the hopper support bar onto the support bar stop.



WARNING: Raised hopper may fall. Engage hopper support bar.



5. Slowly lower the hopper so the hopper support bar rests on the support bar stop.



WARNING: Lift arm pinch point. Stay clear of hopper lift arms.

6. Shut the machine off.



DISENGAGING HOPPER SUPPORT BAR

1. Turn on the machine.



FOR SAFETY: When starting machine, keep foot on brake and directional pedal in neutral.

2. Pull and hold the hopper raise / lower lever back and raise the hopper slightly. Release the lever into the **Hold** position.



3. Put the support bar in its storage position

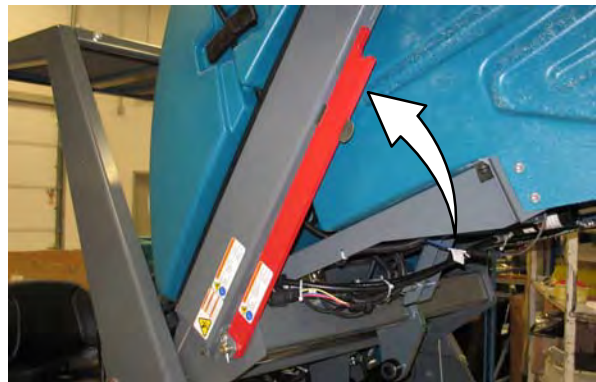

WARNING: Lift arm pinch point. Stay clear of hopper lift arms.

OPERATION

4. Push and hold the hopper raise / lower lever forward to lower the hopper. Release the hopper lever into the **Hold** position.



5. Shut the machine off.



OPTIONS

VACUUM WAND

The vacuum wand uses the machine's vacuum system. The vacuum hose and wand allow pick-up of debris that is out of reach of the machine.

1. Stop the machine within reach of the area to be vacuumed.
2. Set the machine parking brake and turn the machine off.

FOR SAFETY: Before leaving or servicing machine, stop on level surface, set parking brake, and turn off machine.

NOTE: If the operator is not in the seat, the parking brake must be engaged or the machine will automatically shut off.

3. Open the hopper cover and prop the cover open.
4. Remove the vacuum wand from the mounting clips and the hose from the storage compartment.

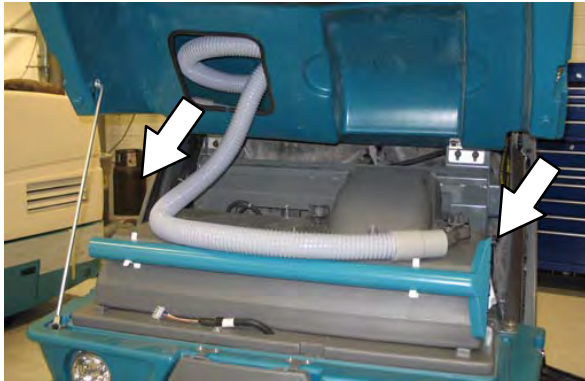

5. Connect the vacuum hose to the vacuum wand.



6. Open the access door located at the front of the machine.



7. Connect the other end of the vacuum hose to the hopper hose connector.



8. Turn on the machine power.
9. Pull and hold the hopper door lever back until the hopper door closed light comes on.



OPERATION

10. Move the vacuum and filter shaker lever into the **Vacuum fan on** position.



11. Vacuum the area as needed.



WARNING: Accident may occur. Do not operate vacuum wand while driving.

12. When finished, push the hopper door lever forward into the **Hopper door open** position to open the hopper door.
13. Shut off the machine.
14. Remove the vacuum hose from the hopper connection.
15. Close the access door.
16. Disconnect the vacuum hose from the vacuum wand.
17. Put the vacuum wand in the mounting clips and hose into the storage compartment.
18. Close the hopper cover.

TOWER BUMPERS (OPTION)

The tower bumpers help protect the machine from being damaged. Open the tower bumpers before opening the seat support.

To open the bumpers:

1. Pull the pin from the bracket and the bumper.

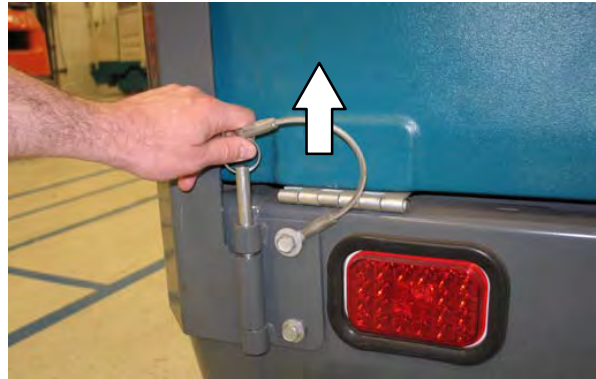

2. Open the tower bumper.



3. Close and secure the tower bumpers before operating the machine.

MACHINE TROUBLESHOOTING

Problem	Cause	Remedy	
Excessive dusting	Hopper door partially or completely closed	Open hopper door	
	Vacuum fan off	Move vacuum and filter shaker lever to Vacuum fan on position	
	Hopper dust filter clogged	Shake and/or clean or replace dust filter	
	Brush skirts and dust seals worn, damaged, out of adjustment	Replace or adjust brush skirts or dust seals	
	Cyclones dirty / clogged	Clear blockage from cyclones	
	Vacuum hose damaged	Replace vacuum hose	
	Vacuum fan failure	Ensure Thermo Sentry wires are connected	Contact TENNANT service personnel
		Thermo-Sentry tripped	Allow Thermo-Sentry to cool
Poor sweeping performance	Brush bristles worn	Replace brushes	
	Main and side brushes not adjusted properly	Adjust main and side brushes	
	Debris caught in main brush drive mechanism	Remove debris from the drive mechanism.	
	Hopper door partially or completely closed	Open hopper door	
	Hopper full	Empty hopper	
	Recirculation flap damaged	Replace flap	
	Wrong sweeping brush	Contact TENNANT representative for recommendations	
	Hopper lip skirts worn or damaged	Replace lip skirts	
	Side brush drive failure	Contact TENNANT service personnel	
	Main brush drive failure	Contact TENNANT service personnel	

MAINTENANCE

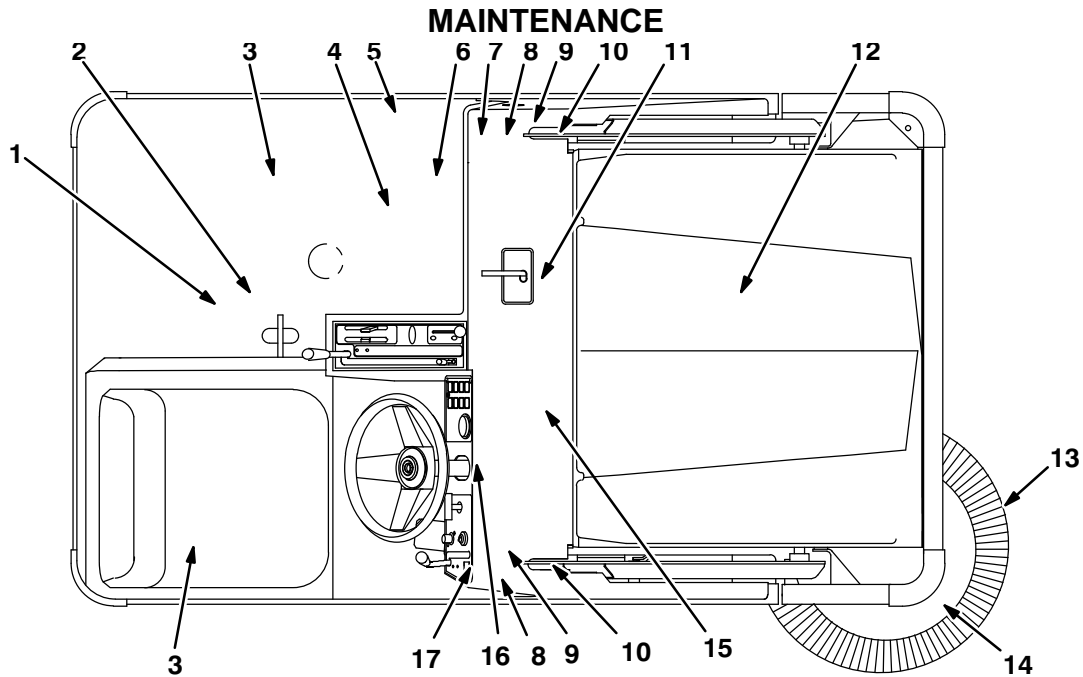

MAINTENANCE CHART

The table below indicates the *Person Responsible* for each procedure.

O = Operator.

T = Trained Personnel.

Interval	Person Resp.	Key	Description	Procedure	Lubricant /Fluid	No. of Service Points
Daily	O	8	Main brush compartment skirts	Check for damage, wear, and adjustment	-	All
	O	15	Hopper lip skirts	Check for damage, wear, and adjustment	-	3
	O	11	Main brush	Check for damage or wear	-	1
	O	13	Side brush(es)	Check for damage or wear	-	1
	O	12	Hopper dust filter	Shake	-	1
	O	4	Hydraulic fluid reservoir	Check fluid level	HYDO	1
Weekly	T	7	Battery cells	Check electrolyte level	DW	12
50 Hours	O	11	Main brush	Rotate end-for-end and check pattern	-	1
	T	11	Main brush	Check brush pattern and adjust if needed	-	1
	T	13	Side brush(es)	Check pattern	-	1
	T	3	Batteries	Check electrolyte level	DW	6 (2)
				Clean and tighten battery cable connections (after initial 50 hours only)	-	1
	T	1	Rear wheel	Torque wheel nuts (after initial 50 hours only)	-	1
	T	1	Propelling gearbox	Change gear lubricant (after initial 50 hours only)	GL	1
Change fill-level plug seals (after initial 50 hours only)				-	1	

Interval	Person Resp.	Key	Description	Procedure	Lubricant /Fluid	No. of Service Points
100 Hours	T	12	Hopper dust filter	Check for damage, clean or replace	-	1
			Cyclone seals	Check for damage or wear	-	All
	O	9	Tires	Check for damage	-	3
	T	1	Propelling gearbox	Check lubricant level	GL	1
	O	8	Main brush and hopper seals	Check for damage or wear	-	8
200 Hours	T	1	Rear wheel support bearings	Lubricate	SPL	1
	T	16	Brakes	Check adjustments	-	1
	T	2	Steering link	Lubricate	SPL	1
	T	10	Hopper lift arm pivots	Lubricate	SPL	2
	T	14	Side brush pivot(s)	Check adjustment	-	1
	T	14	Side brush guard	Rotate 90°	-	1
	T	5	Vacuum fan belt	Check tension and wear	-	1
	T	5	Hydraulic pump belt	Check tension and wear	-	1
	T	5	Main brush intermediate belt	Check tension and wear	-	1
	T	5	Main brush belt	Check for wear	-	1
	T	3	Batteries	Clean and tighten battery cable connections	-	1
400 Hours	T	13	Front wheel bearings	Check for seal damage	-	2
800 Hours	T	4	Hydraulic fluid reservoir	Replace filler cap	-	1
				Replace suction strainer	-	1
	T	6	Hydraulic fluid filter	Change filter element	-	1
	T	-	Hydraulic hoses	Check for wear and damage	-	All
	T	1	Propelling gearbox	Change gear lubricant	GL	1
				Change fill-level plug seals	-	1
	T	1	Rear wheel	Torque wheel nuts	-	1
T	1, 7	Electric motors	Check carbon brushes	-	2	
1200 Hours	T	16	Hydraulic fluid filter	* Change filter element	-	All
2400 Hours	T	15	Hydraulic fluid reservoir	* Replace suction strainer	-	1
				* Change hydraulic fluid	HYDO	1

NOTE: Change the hydraulic fluid, filter, and suction strainer, indicated (), after every 800 hours for machines NOT originally equipped with **Tennant True** premium hydraulic fluid. (See Hydraulics section).*

LUBRICANT/FLUID

DW Distilled water

GL SAE 90 Gear lubricant

HYDO . **Tennant True** premium hydraulic fluid or equivalent

SPL . . . Special lubricant, Lubriplate EMB grease (TENNANT part no. 01433-1)

NOTE: More frequent intervals may be required in extremely dusty conditions.

MAINTENANCE

LUBRICATION

FOR SAFETY: Before leaving or servicing machine, stop on level surface, set parking brake, turn off machine, and remove key.

PROPELLING GEARBOX

Check the lubricant level in the propelling gearbox after every 100 hours of operation. Change the gear lubricant, and the drain and fill-level plug seals after the first 50 hours of operation, and then after every 800 hours of operation.

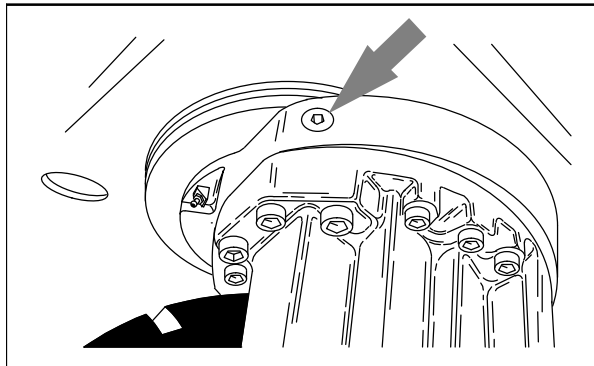

05934

REAR WHEEL SUPPORT

The rear wheel support pivots the rear wheel to steer the machine. The support has two grease fittings for the bearings. Raise the machine so the rear wheel support assembly is off the floor. Fill one of the grease fittings while rotating the gearbox from stop to stop. Fill the second grease fitting while rotating the gearbox back to the original position. The bearing cavity is full when grease comes out of the top seal.

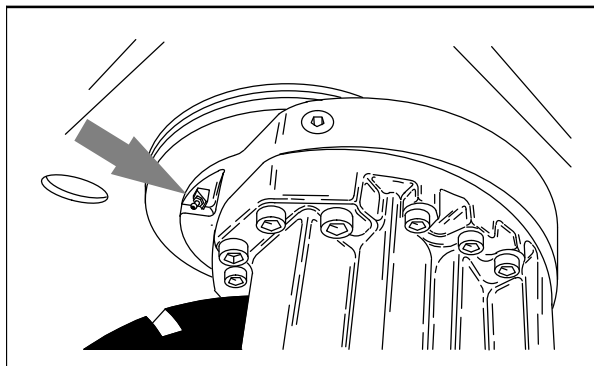

05934

Lubricate the rear wheel support after every 200 hours of machine operation, or after steam cleaning the gearbox area.

FOR SAFETY: When servicing machine, block machine tires before jacking up machine.

FOR SAFETY: When servicing machine, jack up machine at designated locations only. Block machine up with jack stands.

STEERING LINK

Lubricate the steering link after every 200 hours of machine operation.



FRONT WHEEL BEARINGS

Repack and adjust the front wheel bearings every 400 hours of operation.



HOPPER LIFT ARM PIVOTS

Lubricate the hopper lift arm bearings after every 200 hours of operation.

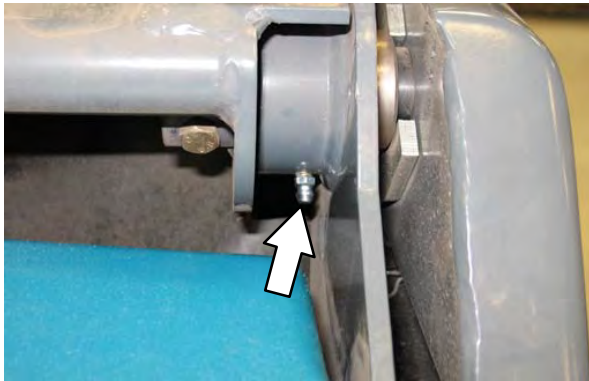

HYDRAULICS

HYDRAULIC FLUID RESERVOIR

Check the hydraulic fluid level and operating temperature daily. The hopper must be down when checking the hydraulic fluid level.



A filler cap is mounted on top of the reservoir. It has a built-in breather and fluid level dipstick. Replace the cap after every 800 hours of operation.

Lubricate the filler cap gasket with a film of hydraulic fluid before putting the cap back on the reservoir.

ATTENTION! Do not overfill the hydraulic fluid reservoir or operate the machine with a low level of hydraulic fluid in the reservoir. Damage to the machine hydraulic system may result.

Drain and refill the hydraulic fluid reservoir with new **Tennant True** premium hydraulic fluid after every 2400 hours of operation. Machines have a blue colored drop (left photo) on the hydraulic fluid label if originally equipped with **Tennant True** premium hydraulic fluid.



Tennant True Fluid



Previous Fluid

*NOTE: Change the hydraulic fluid, filter, and suction strainer after every 800 hours for ALL machines that have NOT consistently used **Tennant True** premium hydraulic fluid or equivalent.*

The reservoir has a built-in strainer outlet that filters hydraulic fluid before it enters the system. Replace the strainer after every 2400 hours of operation.

The hydraulic fluid filter is located in front of the hydraulic reservoir. Replace the filter element after every 1200 hours of operation or if the clogged hydraulic filter light remains on. Check the hydraulic fluid level and refill as needed.

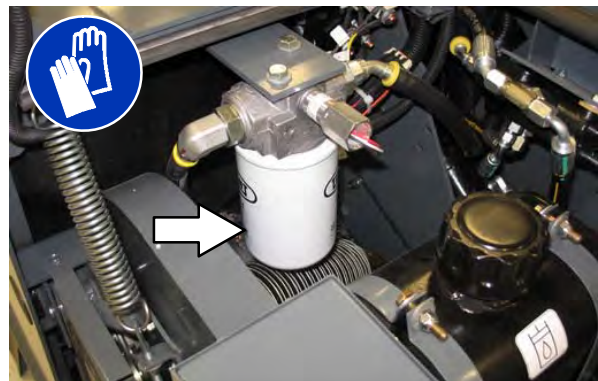

MAINTENANCE

HYDRAULIC FLUID

There is one recommended fluid:

Tennant <i>True</i> premium hydraulic fluid (Extended Life)		
Part number	ISO Grade	Capacity
1057707	32	3.8 L (1 gal)
1057708	32	19 L (5 gal)

If using a locally-available hydraulic fluid, be sure the specifications match the Tennant hydraulic fluid specifications. Substitute fluids can cause premature failure of hydraulic components.

ATTENTION! Hydraulic components depend on system hydraulic fluid for internal lubrication. Malfunctions, accelerated wear, and damage will result if dirt or other contaminants enter the hydraulic system.

HYDRAULIC HOSES

Check the hydraulic hoses after every 800 hours of operation for wear or damage.

FOR SAFETY: When servicing machine, use cardboard to locate leaking hydraulic fluid under pressure.

High pressure fluid escaping from a very small hole can almost be invisible, and can cause injury.

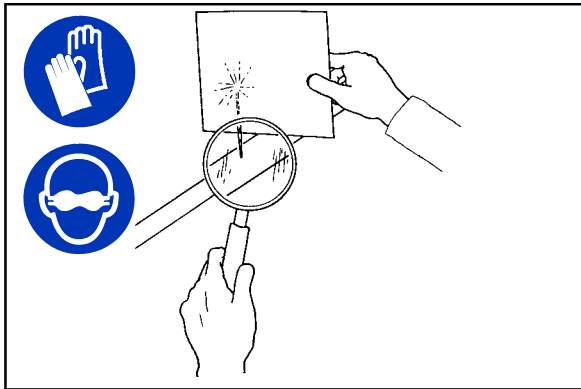

00002

Contact appropriate personnel if a leak is discovered.

ATTENTION: Only use TENNANT supplied hydraulic hoses or equivalent rated hydraulic hoses.

BATTERIES

FOR SAFETY: Before leaving or servicing machine, stop on level surface, turn off machine, set parking brake (if equipped), and remove key.

The lifetime of the batteries depends on their proper maintenance. To get the most life from the batteries;

- Do not charge the batteries more than once a day and only after running the machine for a minimum of 15 minutes.
- Do not leave the batteries partially discharged for long period of time.
- Only charge the batteries in a well-ventilated area to prevent gas build up. Charge batteries in areas with ambient temperatures 27°C (80°F) or less.
- Allow the charger to complete charging the batteries before re-using the machine.
- Maintain the proper electrolyte levels of flooded (wet) batteries by checking levels weekly.

CHECKING THE ELECTROLYTE LEVEL

The flooded (wet) lead-acid batteries require routine maintenance as described below. Check the battery electrolyte level weekly.

NOTE: Do Not check the electrolyte level if the machine is equipped with the battery watering system. Proceed to the BATTERY WATERING SYSTEM (OPTION).

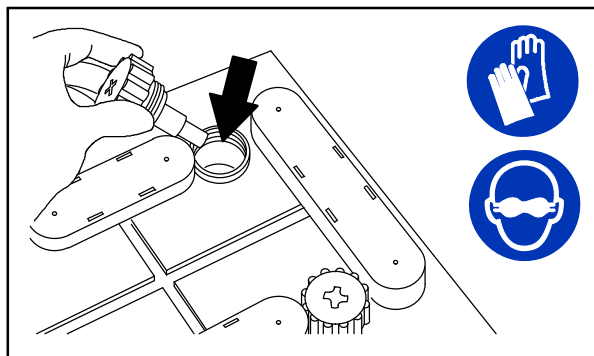

08247

FOR SAFETY: When servicing machine, keep all metal objects off batteries. Avoid contact with battery acid.

The level should be slightly above the battery plates as shown before charging. Add distilled water if low. **DO NOT OVERFILL.** The electrolyte will expand and may overflow when charging. After charging, distilled water can be added up to about 3 mm (0.12 in) below the sight tubes.

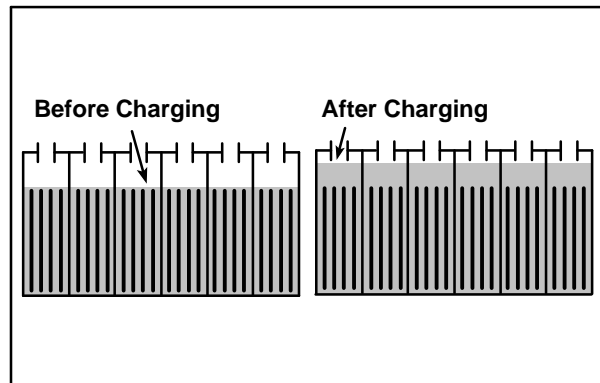

NOTE: Make sure the battery caps are in place while charging. There may be a sulfur smell after charging batteries. This is normal.

MAINTENANCE-FREE BATTERIES

Maintenance-free batteries do not require watering. Cleaning and other routine maintenance is still required.

CHECKING CONNECTIONS / CLEANING

After every 200 hours of use check for loose battery connections and clean the surface of the batteries, including terminals and cable clamps, with a strong solution of baking soda and water. Replace any worn or damaged wires. Do not remove battery caps when cleaning batteries.



MAINTENANCE

CHARGING THE BATTERIES (OFF-BOARD CHARGER)

IMPORTANT: Before charging, make sure that the charger setting is properly set for the battery type.

1. Drive the machine to a flat, dry surface in a well-ventilated area.
2. Stop the machine and turn off the machine power.

FOR SAFETY: Before leaving or servicing machine, stop on level surface, turn off machine, and remove key.

3. Open the main cover.

NOTE: Make sure the batteries have the proper electrolyte level before charging. See CHECKING THE ELECTROLYTE LEVEL.

4. Plug the charger AC power supply cord into a properly grounded outlet.
5. Unplug the battery connector from the machine connector.

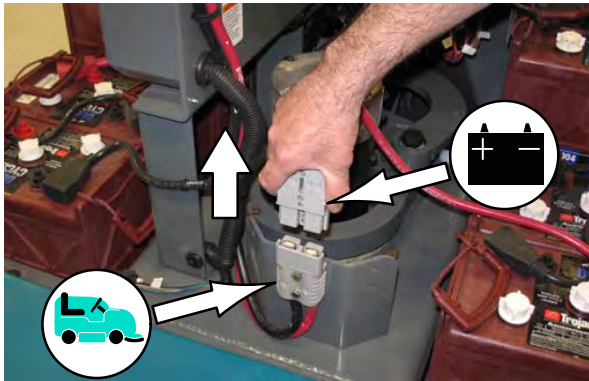

6. Plug the charger connector into the battery connector.

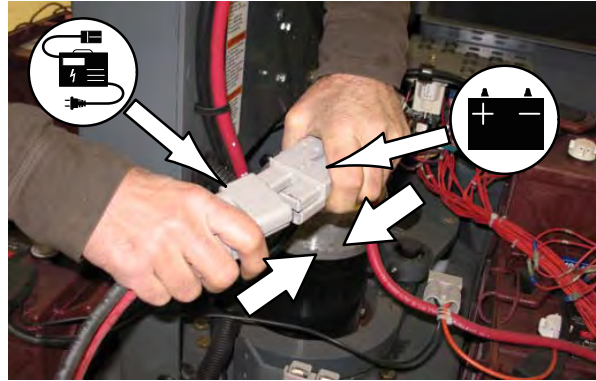

WARNING: Batteries emit hydrogen gas. Explosion or fire can result. Keep sparks and open flame away. Keep covers open when charging.

NOTE: If the charger "FAULT CODE" lights flash when the batteries are plugged into the charger, refer to the charger manufacturer manual for fault code definitions.

- The Tennant charger will start automatically. When the batteries are fully charged, the Tennant charger will automatically turn off.



NOTE: Use a charger with the proper rating for the batteries to prevent damage to the batteries or reduce the battery life.

NOTE: If the charger needs to be disconnected from the machine before the batteries are fully charged and the charger has not automatically shut off, turn off the charger before disconnecting

- After the charger has turned off, unplug the charger connector from the battery connector on the machine.

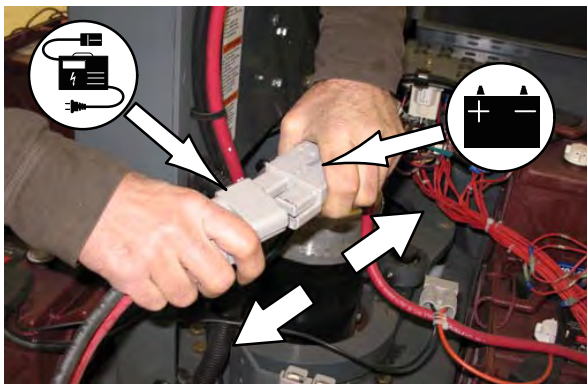

ATTENTION: Do not disconnect the charger DC cord from the machine receptacle when the charger is operating. Arcing may result. If the charger must be interrupted during charging, disconnect the AC power supply cord first.

- Reconnect the battery connector to the machine connector.

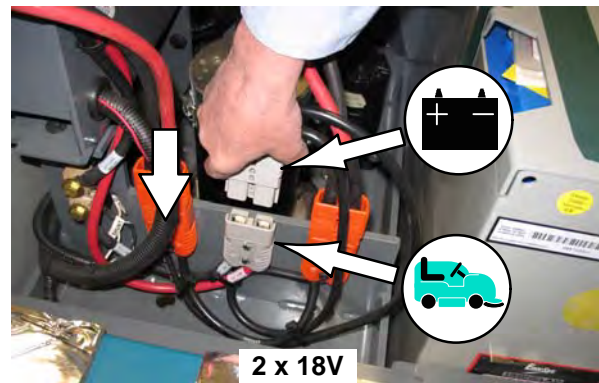
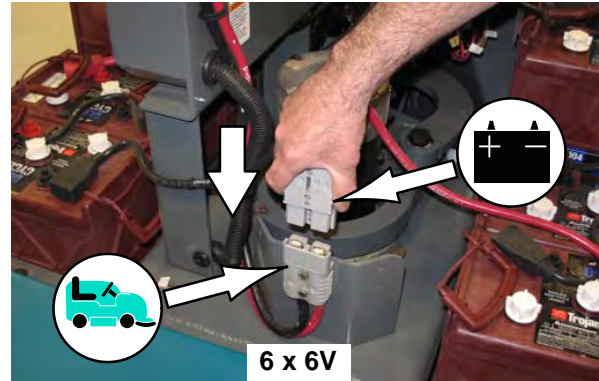

- Close the main cover.

FUSES , RELAYS, AND CIRCUITBREAKERS

FUSES

Fuses are one-time protection devices designed to stop the flow of current in the event of a circuit overload. Never substitute higher value fuses than specified.

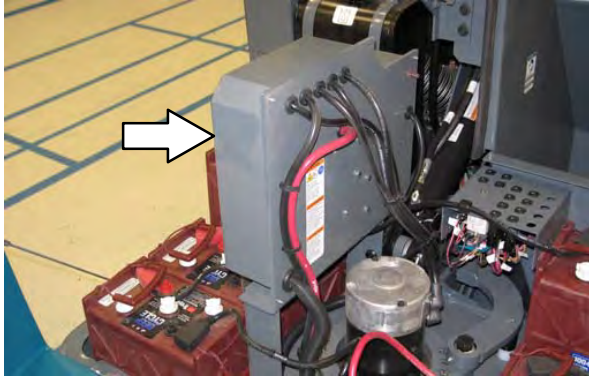

The fuses are located in the control box.

Fuse	Rating	Circuit Protected
FU-1	100 A	Hydraulic pump motor
FU-2	80 A	Propelling

RELAYS

Relays are electrical switches that open and close under the control of another electrical circuit. Relays are able to control an output circuit of higher power than the input circuit. The relays are located in the electrical control panel and near the circuit breaker panel.

Refer to the table below for the *relays* and circuits controlled.

Relay	Rating	Circuit Controlled
M1	36 VDC, 100 A	Main contactor
M2	36 VDC, 100 A	Hydraulic pump
M3	36 VDC, 100 A	Forward
M4	36 VDC, 100 A	Reverse
M5	36 VDC, 100 A	Backup alarm / light
M6	36 VDC, 100 A	Filter shaker
M7	36 VDC, 100 A	Thermo-Sentry

CIRCUIT BREAKERS

The circuit breakers are resettable electrical circuit protection devices. Their design stops the flow of current in the event of a circuit overload. Once a circuit breaker is tripped, it must be reset manually. Press the reset button after the breaker has cooled down.



If the overload that caused the circuit breaker to trip is still there, the circuit breaker will continue to stop current flow until the problem is corrected.

The circuit breakers are located underneath the operator seat.

The chart lists the circuit breakers and the electrical components they protect.

Circuit Breaker	Rating	Circuit Protected
CB-1	2.5 A	Horn
CB-2	20 A	Hopper
CB-3	15 A	Operating lights
CB-4	2.5 A	Hour meter / Shaker contact
CB-5	2.5 A	Strobe light (option)
CB-6	2.5 A	Taillights
CB-7	2.5 A	Right side brush
CB-8	2.5 A	Indicators
CB-9	2.5 A	Right / left spin valve (option)
CB-10	2.5 A	Thermo-Sentry
CB-11	2.5 A	Seat switch
CB-12	2.5 A	Key switch – run
CB-13	2.5 A	Key switch – start
CB-14	2.5 A	13 VDC Fan (option)
CB-15	2.5 A	Extra spare #1
CB-16	2.5 A	Extra spare #2
CB-17	5 A	Flasher (option)
CB-18	–	Not used
CB-19	–	Not used

ELECTRIC MOTORS

The carbon brushes on the propelling and accessories motors should be inspected after every 800 hours of machine operation.

MAINTENANCE

BELTS

FOR SAFETY: Before leaving or servicing machine, stop on level surface, set parking brake, turn off machine, and remove key.

HYDRAULIC PUMP BELT

Check the hydraulic pump belt tension and wear after every 200 hours of operation. The correct tension is when the belt at midpoint deflects 4 mm (0.15 in) from a force of 2.5 kg (5.5 lb).

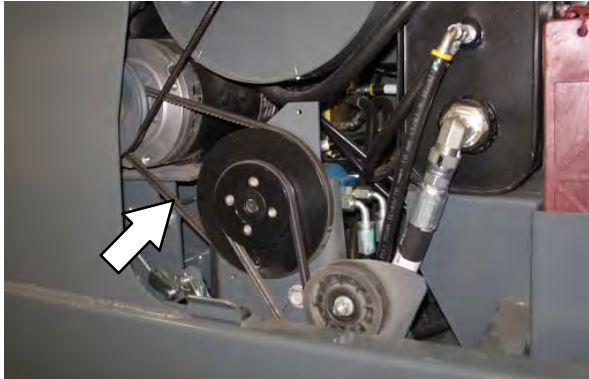

! WARNING: Moving belt. Keep away.

VACUUM FAN BELT

Check the vacuum fan belt tension and wear after every 200 hours of operation. The correct tension is when the belt deflects 4 mm (0.16 in) from a force of 0.7 kg (1.5 lb) at belt midpoint.

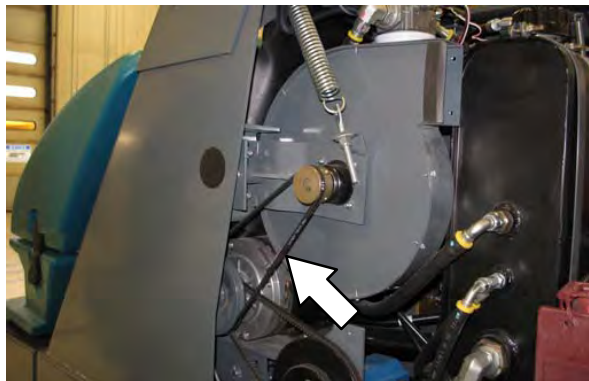

MAIN BRUSH INTERMEDIATE BELT

Check the main brush intermediate belt tension and for wear after every 200 hours of operation. The correct tension is when the belt deflects 8 mm (0.3 in) from a force of 2.3 kg (5 lb) at belt midpoint.

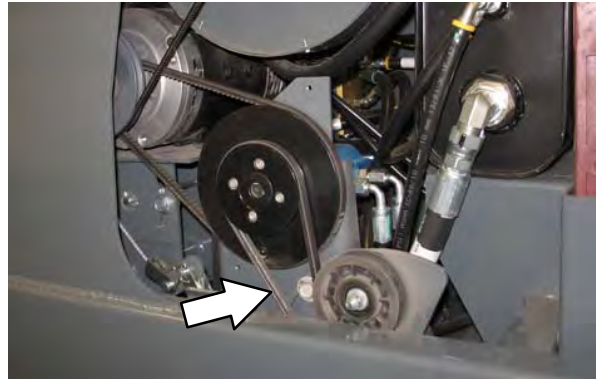

! WARNING: Moving belt. Keep away.

MAIN BRUSH BELT

Check the main brush belt for wear after every 200 hours of operation. The spring idler keeps tension on the belt.

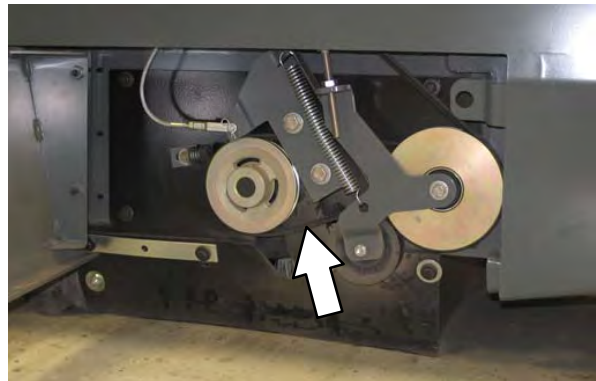

HOPPER DUST FILTER

FOR SAFETY: Before leaving or servicing machine, stop on level surface, set parking brake, turn off machine, and remove key.

REPLACING THE HOPPER DUST FILTER

Shake the dust filter at the end of every shift and before removing the filter from the machine. Inspect and clean the filter after every 100 hours of operation. Replace damaged dust filters.

NOTE: Clean the filter more often if used in extremely dusty conditions.

1. Unlatch and open the hopper cover. Support the hopper cover open with the hopper cover prop rod.

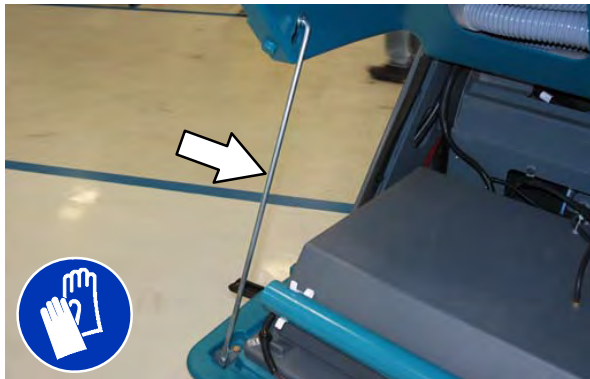

2. Remove the dust filter cover.



3. Remove the dust filter from the hopper.



4. Clean or discard the dust filter element. Refer to *CLEANING THE DUST FILTER*.
5. Clean dust and debris from the dust filter tray.



6. Reinstall the dust filter.
7. Reinstall the dust filter cover.
8. Close the hopper cover.

MAINTENANCE

CLEANING THE HOPPER DUST FILTER

Use one of the following methods to clean the dust filter:

SHAKING—Press the *filter shaker switch*.

TAPPING—Tap the filter gently on a flat surface. **Do not damage the edges of the filter.** The filter will not seal properly if the edges of the filter are damaged.

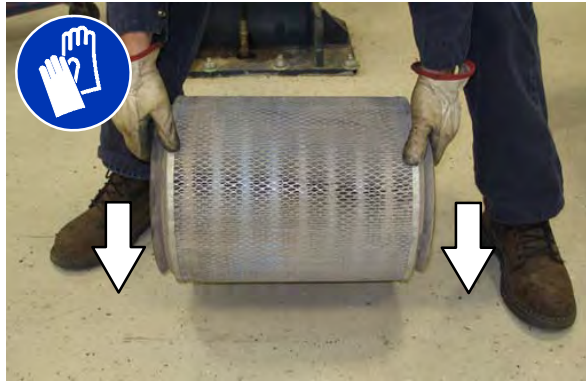

AIR—Always wear eye protection when using compressed air. Blow air through the center of the filter and out toward the exterior. Never use more than 550 kPa (80 psi) of air pressure with a nozzle no smaller than 3 mm (0.13 in) and never hold the nozzle closer than 50 mm (2 in) to the filter.



CLEANING THE CYCLONE ASSEMBLY

FOR SAFETY: Before leaving or servicing machine, stop on level surface, set parking brake, turn off machine, and remove key.

Clean the cyclones and filter housing after every 100 hours of operation.



CYCLONE DUST TRAY SEALS

Check the cyclone dust tray seals for wear, damage, and debris buildup every 100 hours of operation.

NOTE: It is not necessary to remove the cyclone assembly from the machine to check / clean the seals.



CYCLONE PERMA-FILTER

Clean heavy or wet dust and excess debris from the cyclone perma-filter as necessary. Check the cyclone perma-filter for damage every 100 hours of operation.

**CYCLONE COVER SEALS**

Check the cyclone cover seals for wear or damage every 100 hours of operation. Clean dust and debris from the cyclones as necessary.

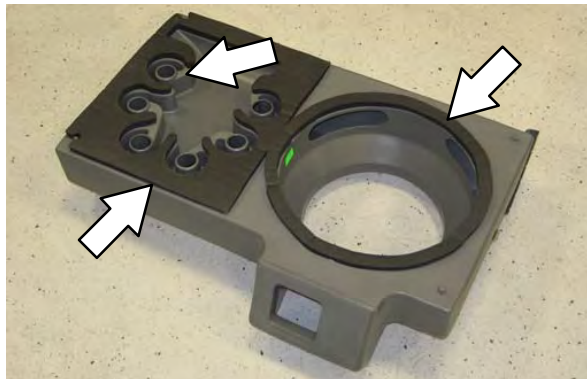
**HOPPER DUST FILTER COVER SEAL**

Check the hopper dust filter cover seal for wear or damage every 100 hours of operation. Clean dust and debris from the seal as necessary.



MAIN BRUSH

FOR SAFETY: Before leaving or servicing machine, stop on level surface, set parking brake, turn off machine, and remove key.

Check the brush daily for wear or damage. Remove any string or wire tangled on the main brush, main brush drive hub, or main brush idler hub.



Check the main brush pattern and rotate the brush end-for-end after every 50 hours of operation, for maximum brush life and best sweeping performance. Refer to *REPLACING OR ROTATING THE MAIN BRUSH*.

Replace the brush when it no longer cleans effectively.

REPLACING OR ROTATING THE MAIN BRUSH

1. Raise the brush head.

FOR SAFETY: Before leaving or servicing machine, stop on level surface, set parking brake, turn off machine, and remove key.

2. Open the right side main brush access door.
3. Loosen the brush idler plate T-bolt. Remove the brush idler arm assembly.

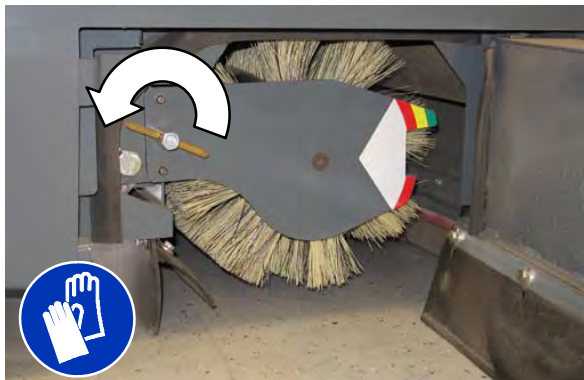

4. Pull the main brush from the main brush compartment.



5. Replace or rotate the main brush end-for-end.
6. Slide the brush into the brush compartment and all the way onto the drive plug.
7. Reinstall the brush idler plate.

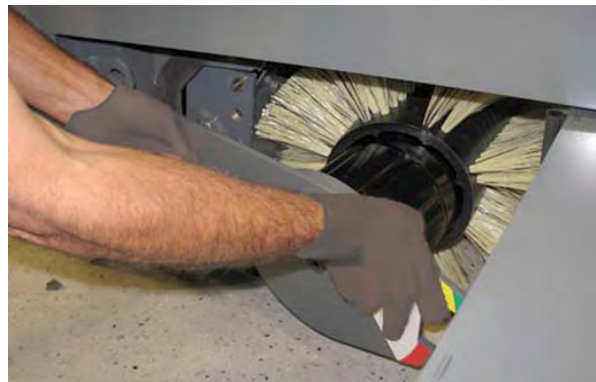

8. Close the main brush access door.
9. Check and adjust the brush pattern if needed. Refer to *CHECKING THE MAIN BRUSH PATTERN*.

CHECKING THE MAIN BRUSH PATTERN

1. Apply chalk, or a similar marking material, to a smooth and level section of the floor.

NOTE: If chalk or other material is not available, allow the brush to spin on the floor for two minutes. A polish mark will remain on the floor.

2. Lower the main brush onto the chalked area and hold it there for 15 to 20 seconds without moving the machine.
3. Raise the brush and drive the machine from the chalked area. The brush pattern should be 50 to 75 mm (2.0 to 3.0 in) across the entire length of the brush. Refer to *ADJUSTING THE MAIN BRUSH WIDTH*.

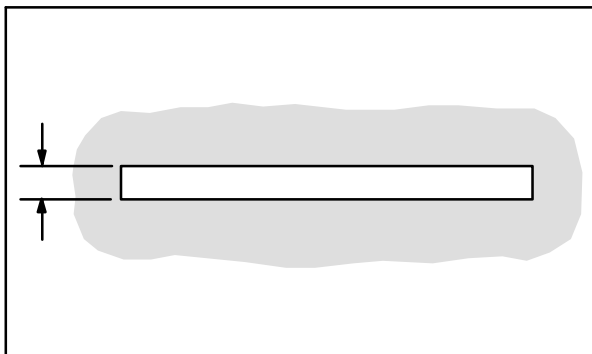

00582

FOR SAFETY: Before leaving or servicing machine, stop on level surface, set parking brake, turn off machine, and remove key.

4. If the brush pattern is tapered, see *ADJUSTING THE MAIN BRUSH TAPER* section of this manual.

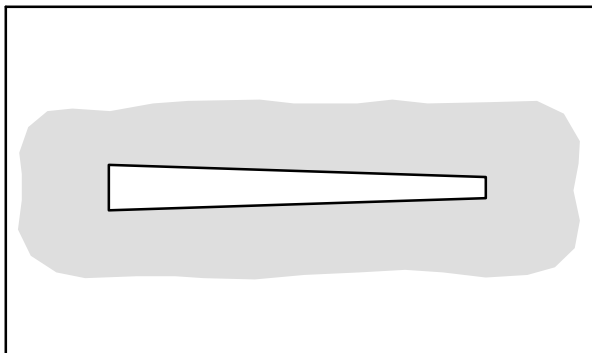

00601

ADJUSTING THE MAIN BRUSH TAPER

FOR SAFETY: Before leaving or servicing machine, stop on level surface, set parking brake, turn off machine, and remove key.

1. Remove the brush idler plate and brush.
2. Loosen the shaft bearing bracket mounting bolts.

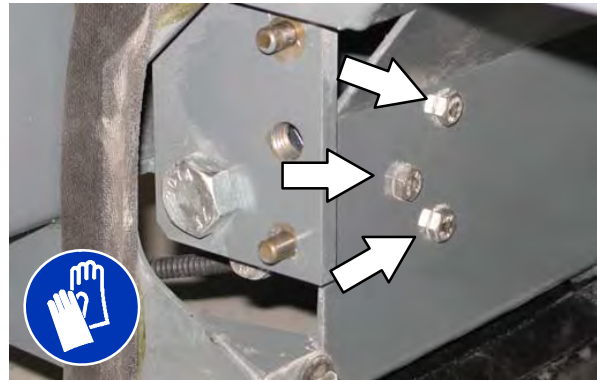

3. Move the bracket up or down in the slots and tighten the mounting bolts.
4. Reinstall the brush and brush idler plate.
5. Check the main brush pattern and readjust as necessary. Maximum taper is 13 mm (0.5 in). Set the main brush adjustment knob pointer to the same color band as the brush idler plate.

MAINTENANCE

ADJUSTING THE MAIN BRUSH WIDTH

FOR SAFETY: Before leaving or servicing machine, stop on level surface, set parking brake, turn off machine, and remove key.

1. Compare the length of the main brush bristles with the color band on the brush idler plate.



2. Loosen the main brush adjustment knob and slide the pointer so it matches the color band on the brush idler plate. Retighten the knob.

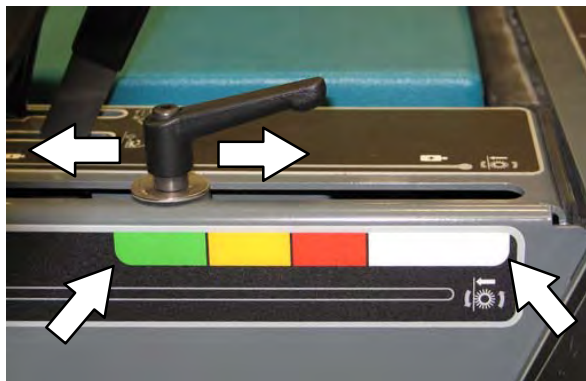

3. Recheck the pattern. Readjust if necessary.

SIDE BRUSH(ES)

Check the brush(es) daily for wear or damage. Remove any string or wire found tangled in the brush(es) or drive hub(s).

Replace the brush(es) when it no longer cleans effectively.

REPLACING THE SIDE BRUSH

1. Stop the machine, set the parking brake and turn the engine off.

FOR SAFETY: Before leaving or servicing machine, stop on level surface, set parking brake, turn off machine, and remove key.

2. Remove the side brush retaining pin from the side brush drive shaft by pulling the pin keeper off over the end of the pin.

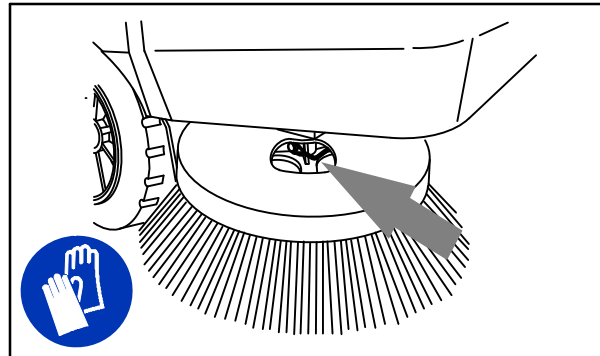

08019

3. Slide the side brush off the side brush drive shaft.

NOTE: Remove the drive hub and put it on the new brush if one is not installed.

4. Slide the new side brush onto the side brush drive shaft.
5. Insert the side brush retaining pin through the side brush hub and shaft.
6. Secure the pin by clipping the pin keeper over the end of the pin.
7. Adjust the side brush pattern with the side brush down pressure knob.

ADJUSTING THE SIDE BRUSH PATTERN

Check the side brush pattern after every 50 hours of operation. The side brush bristles should touch the floor in the patterns shown in the illustration.

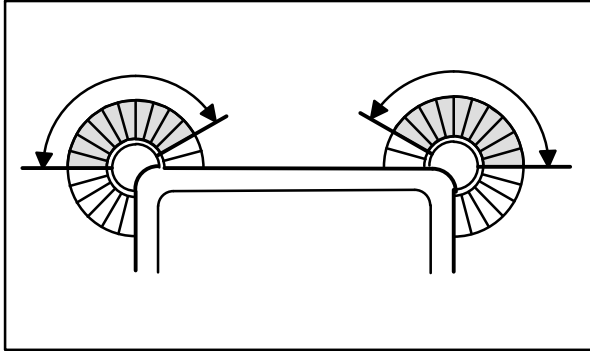

Turn the knob(s) counterclockwise to increase the brush pressure and clockwise to decrease the brush pressure.



SIDE BRUSH GUARD

Rotate the side brush guard 90° after every 200 hours of operation, or sooner if worn. Replace the brush guard after using all four sides.



SIDE BRUSH PIVOT

The side brush pivot should be checked for excessive movement after every 200 hours of operation.

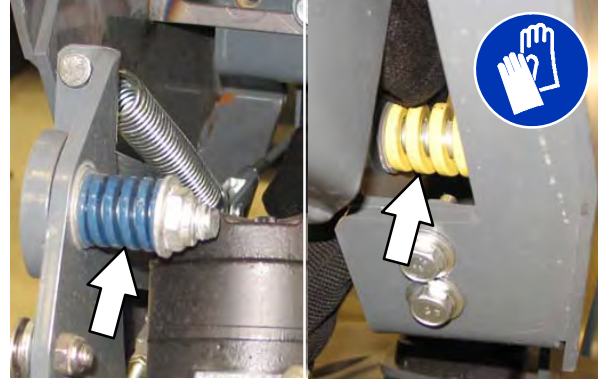

The side brush side tilt (left to right) is adjusted with the two bolts.

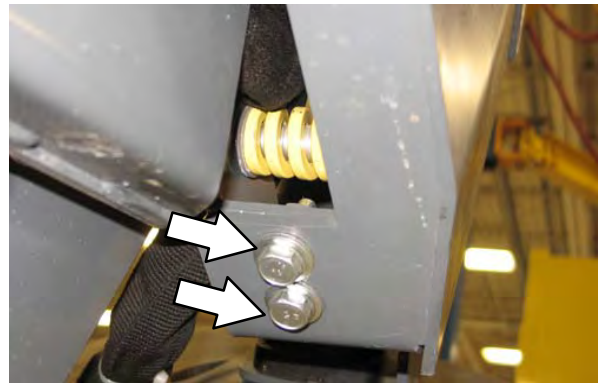

The side brush front to rear tilt is adjusted with the side brush cable and clevis pin.



SKIRTS, FLAPS, AND SEALS

FOR SAFETY: Before leaving or servicing machine, stop on level surface, set parking brake, turn off machine, and remove key.

HOPPER LIP SKIRT

The hopper lip skirt is located on the bottom rear of the hopper. The skirt floats over debris and helps deflect that debris into the hopper.

Check the hopper lip skirt for wear or damage daily.

Replace the hopper lip skirt when it no longer touches the floor.

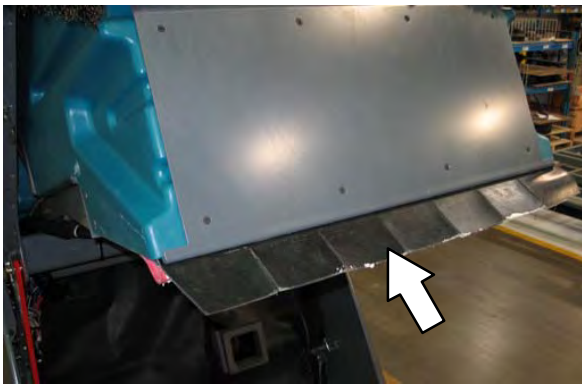

HOPPER SIDE SKIRT

The hopper side skirt is located on the left side of the hopper. The hopper side skirt should clear the floor by 3 mm (0.12 in).

Check the hopper side skirt for wear or damage and adjustment daily.

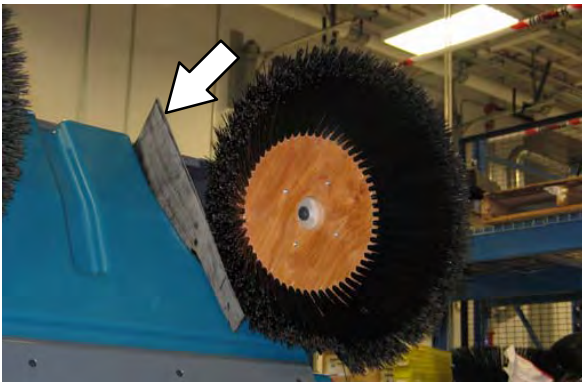

BRUSH DOOR SKIRTS

The brush door skirts are located on the bottom of each of the two main brush doors. The skirt should clear the floor by 3 mm (0.12 in).

Check the skirts for wear or damage and adjustment daily.

NOTE: The brush door skirts have slotted holes to allow for a ground clearance adjustment. Adjust the skirt height with the door closed.

NOTE: Rear tire pressure will affect skirt clearances.

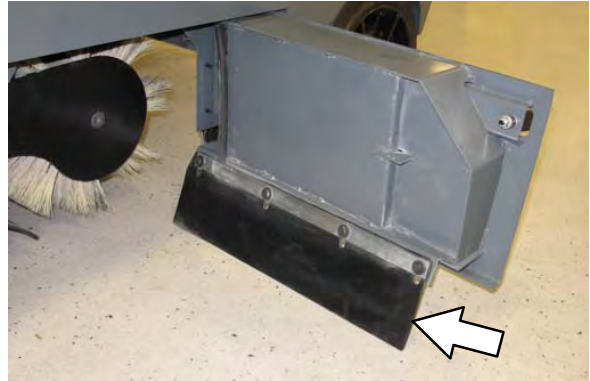

REAR SKIRTS

The two rear skirts are located on the bottom rear of the main brush compartment. The vertical skirt should clear the floor up to 3 mm (0.12 in). The recirculation skirt requires no adjustment.

Check the skirts for wear or damage and adjustment daily.

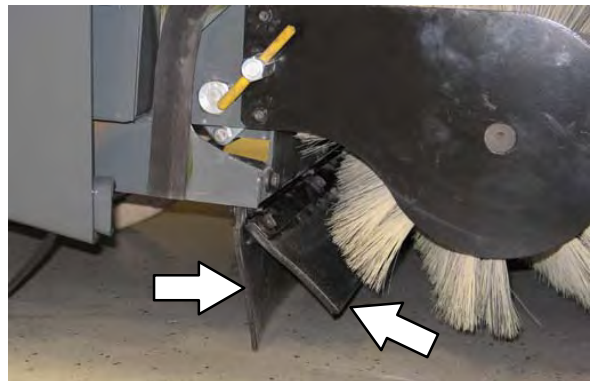

SIDE BRUSH DUST CONTROL SKIRTS (OPTION)

The side brush dust control skirts wrap around the side brush and the front bumper.

Check the side brush dust control skirts for wear or damage daily.

**BRUSH DOOR SEALS**

The brush door seals are located on both main brush doors and on corresponding portions of the main frame.

Check the seals for wear or damage after every 100 hours of operation.

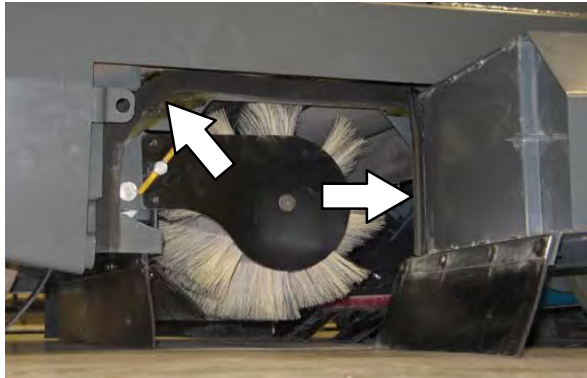
**HOPPER SEALS**

The hopper seals are located on the top and side portions of the hopper.

Check the seals for wear or damage after every 100 hours of operation.

**HOPPER ACCESS DOOR SEAL**

The hopper access door seal is located on the hopper and seals the front of the debris hopper.

Check the seal for wear or damage after every 100 hours of operation.



MAINTENANCE

INNER HOPPER ACCESS DOOR SEAL (OPTION – VACUUM WAND ONLY)

The inner hopper access door seal is located on the hopper and seals the front of the debris hopper.

Check the seal for wear or damage after every 100 hours of operation.



FILTER CHAMBER INLET SEAL

Check the filter chamber inlet seal for wear or damage every 100 hours of operation.



HOPPER DOOR SEALS

The hopper door seals are located on the hopper door. They seal the hopper when the hopper door is closed.

Check the seals for wear or damage after every 100 hours of operation.

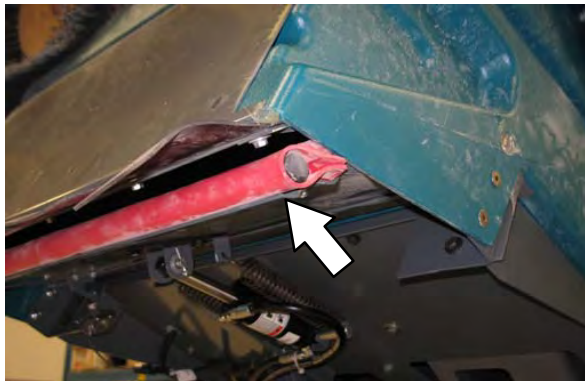

BRAKES AND TIRES

BRAKES

The mechanical brakes are located on the front wheels. The brakes are operated by the foot brake pedal and connecting rods.

Check the brake adjustment after every 200 hours of operation.

To check the brake adjustment, measure the distance from the stationary brake pedal to the point where there is resistance in the pedal movement. The distance must be between 12 mm (0.5 in) and 25 mm (1.0 in). Adjust the brakes if required.

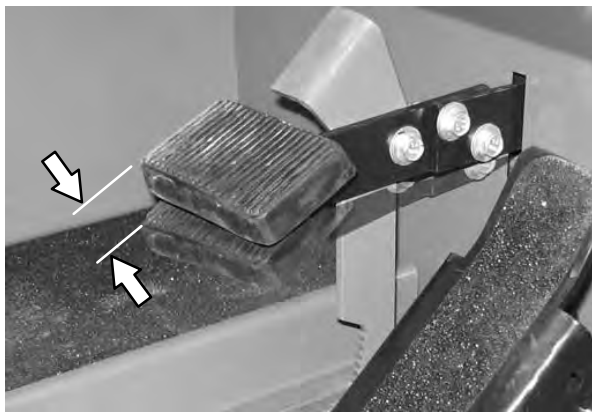

TIRES

All the tires on the machine are solid. Check the front tires after every 100 hours of operation for damage.



REAR WHEEL

Torque the rear wheel nuts twice in the pattern shown to 122–155 Nm (90–110 ft lb) after the first 50 hours of operation, and every 800 hours of operation.

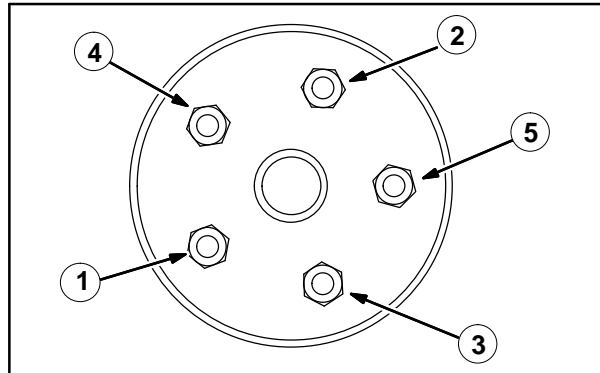

PUSHING, TOWING, AND TRANSPORTING THE MACHINE

PUSHING OR TOWING THE MACHINE

If the machine becomes disabled, it can be pushed from the front or rear, but only towed from the rear.

Only push or tow the machine for a *very short distance* and do not exceed 3.2 kp/h (2 mph). It is NOT intended to be pushed or towed for a long distance or at a high speed.

TRANSPORTING THE MACHINE

1. Position the machine at the loading edge of the truck or trailer.

FOR SAFETY: When loading machine onto truck or trailer, empty hopper before loading machine. Do not load/unload on ramp inclines that exceed 25% grade.

2. If the loading surface is not horizontal or is higher than 380 mm (15 in) from the ground, use a winch to load machine.

If the loading surface is not horizontal or is higher than 380 mm (15 in) from the ground, use a winch to load machine.



3. To winch the machine onto the truck or trailer, attach the winching chains to the rear tie down locations. The rear tie-down locations are the holes in the sides of the machine frame near the rear bumper.

FOR SAFETY: When loading machine onto truck or trailer, use winch. Do not drive the machine onto the truck or trailer unless the loading surface is horizontal AND is 380 mm (15 in) or less from the ground.

4. Position the machine onto the truck or trailer as far as possible. If the machine starts to veer off the center line of the truck or trailer, stop and turn the steering wheel to center the machine.
5. Set the parking brake and block the machine tires. Tie down the machine to the truck or trailer before transporting.

The front tie-down locations are the holes in the wheel pockets at the front of the machine frame.



The rear tie-down locations are the holes in the sides of the machine frame near the rear bumper.



6. If the loading surface is not horizontal or is higher than 380 mm (15 in) from the ground, use a winch to unload machine.

If the loading surface is horizontal AND is 380 mm (15 in) or less from the ground, the machine may be driven off the truck or trailer.

FOR SAFETY: When loading machine onto truck or trailer, use winch. Do not drive the machine onto the truck or trailer unless the loading surface is horizontal AND is 380 mm (15 in) or less from the ground.

MACHINE JACKING

Empty the hopper before jacking up the machine. Jack up the machine at the designated locations. Use a hoist or jack capable of supporting the weight of the machine. Use jack stands to support the machine.

FOR SAFETY: Before leaving or servicing machine, stop on level surface, set parking brake, turn off machine, and remove key.

FOR SAFETY: When servicing machine, block machine tires before jacking machine up. Use a hoist or jack that will support the weight of the machine. Jack machine up at designated locations only. Support machine with jack stands.

The rear jacking location is the center of the rear bumper.



Front jacking locations are located on the frame directly in front of the front tire.



STORAGE INFORMATION

The following steps should be taken prior to storing the machine for extended periods.

1. Park the machine in a cool, dry area. Do not expose the machine to rain or snow. Store indoors.
2. Remove the batteries, or charge batteries every three months.

NOTE: To prevent potential machine damage store machine in a rodent and insect free environment..

SPECIFICATIONS

SPECIFICATIONS

GENERAL MACHINE DIMENSIONS/CAPACITIES

Item	Dimension/capacity
Length	2090 mm (82.3 in)
Length with side brush	2248 mm (88.5 in)
Width	1230 mm (48.5 in)
Width with side brush	1395 mm (55 in)
Height without overhead guard	1260 mm (49.5 in)
Height with overhead guard	2085 mm (82.1 in)
Track	1135 mm (44.7 in)
Wheelbase	1085 mm (42.7 in)
Main sweeping brush diameter	355 mm (14 in)
Main sweeping brush length	910 mm (36 in)
Side brush diameter	580 mm (23 in)
Sweeping path width with side brush	1270 mm (50 in)
Sweeping path width with dual side brushes	1575 mm (62 in)
Main sweeping brush pattern width	50 to 75 mm (2 to 3 in)
Hopper weight capacity	295 kg (650 lb)
Hopper volume capacity	310 L (11 ft ³)
Dust filter area	7.4 m ² (80 ft ²)
Minimum ceiling dump height	2490 mm (98 in)
Weight – without batteries	1045 kg (2300 lb)
Weight – with batteries	1350 kg (2975 lb)
GVWR (Gross Vehicle Weight Rating)	2028 kg (4470 lb)
Protection Grade	IPX3

Values determined as per EN 60335-2-72	Measure
Sound pressure level L_{pA}	80 dB(A)
Sound uncertainty K_{pA}	1.7 dB(A)
Sound power level L_{WA} + Uncertainty K_{WA}	100 dB(A)
Vibration – Hand–arm	<2.5m/s ²
Vibration – Whole body	<0.5m/s ²

GENERAL MACHINE PERFORMANCE

Item	Measure
Maximum forward speed	8 km/h (5 mph)
Maximum reverse speed	4.8 km/h (3 mph)
Minimum aisle turn width, left	2415 mm (95 in)
Minimum turning radius, right	2113 mm (83.2 in)
Minimum turning radius, left	1625 mm (64 in)
Maximum ramp incline for loading – empty hopper	17.6%
Maximum ramp incline for transporting (GVWR)	14%

POWER TYPE

Type	Quantity	Volts	Ah Rating	Weight
Batteries (Max. battery dimensions): 178 mm (7 in) W x 297 mm (11.7 in) L x 424 mm (16.7 in) H or 282 mm (11.1 in) W x 485 (19.1 in) L x 590 mm (23.25 in) H	6	6	315 @ hr rate	58 kg (127 lb)
	2	18	340 @ hr rate	245 kg (540 lb)
	2	18	440 @ hr rate	299 kg (660 lb)

Type	Use	VDC	Kw (hp)
Electric Motors	Propelling	36	1.6 (2.1)
	Accessory	36	3 (4)

Type	VDC	A	Hz	Phase	VAC
Chargers	36	50	60	1	240
	36	75	60	1	variable
	36	75	60	3	variable
	36	50	50	1	230
	36	75	50	3	variable
	36	45	50/60	1	variable

STEERING

Type	Power source	Emergency steering
Rear wheel, hydraulic cylinder and rotary valve controlled	Hydraulic accessory pump	Manual

HYDRAULIC SYSTEM

System	Capacity	Fluid Type
Hydraulic reservoir	10.6 L (2.8 gal)	ISO Grade 32
Hydraulic total	12.1 L (3.2 gal)	
Propelling gearbox	2.6 L (2.7 qt)	SAE 90 Gear weight lubricant

SPECIFICATIONS

BRAKING SYSTEM

Type	Operation
Service brakes	Mechanical drum brakes (2), one per front wheel, cable actuated
Parking brake	Utilizes service brakes, cable actuated

TIRES

Location	Type	Size
Front (2)	Solid	89 x 410 mm (3.5 X 16 in)
Rear (1)	Solid	102 x 410 mm (4 x 16 in)

MACHINE DIMENSIONS

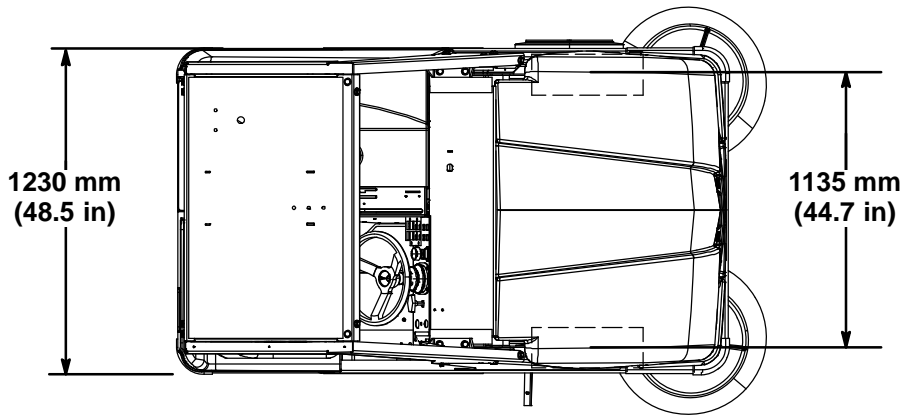

TOP VIEW

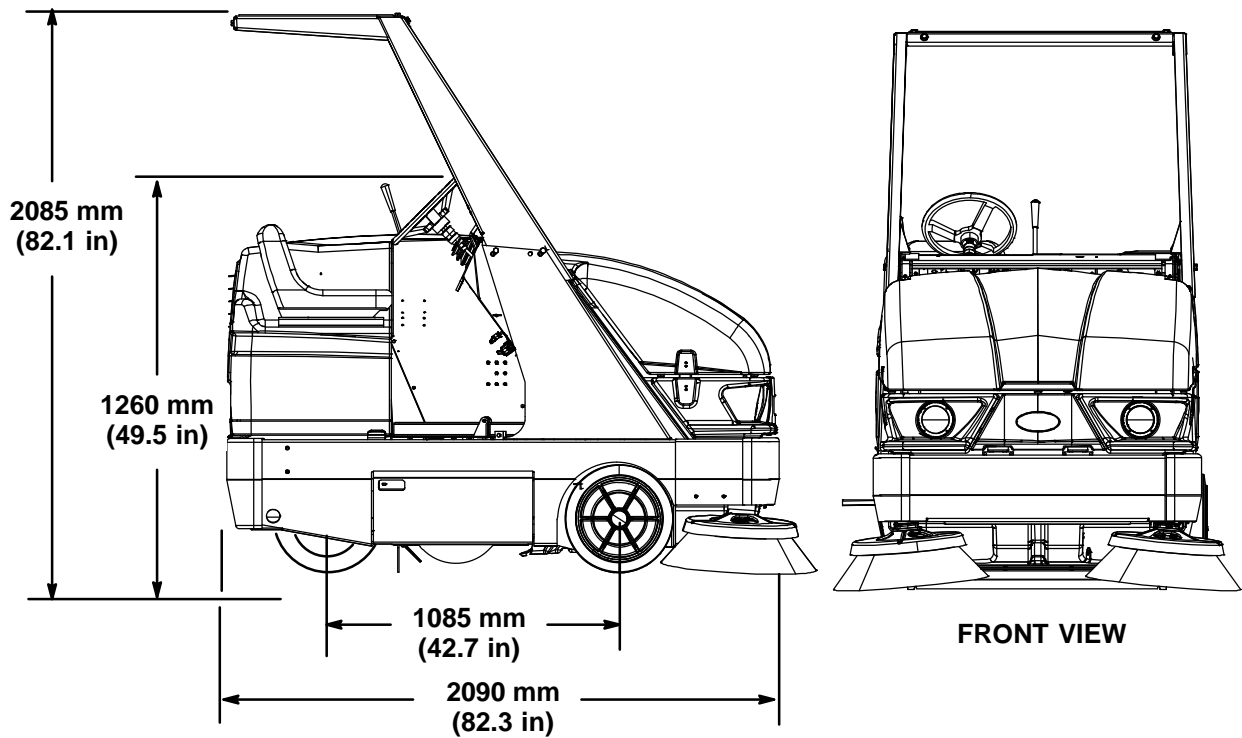

FRONT VIEW

SIDE VIEW

354901

A

Adjust operator seat, 16
 Adjusting the Main Brush Taper, 47
 Adjusting the Main Brush Width, 48
 Aisle turn, 57

B

Batteries, 37
 Charger specifications, 57
 Charging batteries (off-board charger), 38
 Checking connections / cleaning, 37
 Checking the electrolyte level, 37
 Discharge indicator, 15
 Maintenance, 37
 Specifications, 57
 Battery, Charging system, Light, 14
 Battery discharge indicator, 11, 15
 Bearings, Rear wheel support, 34
 Belts, 42
 Hydraulic pump, 42
 Main brush, 42
 Main brush intermediate, 42
 Vacuum Fan, 42
 Brake pedal, 12
 Brakes, 53
 System specifications, 58
 Brakes and Tires, 53
 Brakes, 53
 Rear Wheel, 53
 Tires, 53
 Brush door seals, 51
 Brush door skirts, 50
 Brush Information, 17
 Brushes
 Adjust side brush pattern, 49
 Checking main brush pattern, 47 – 49
 Checking side brush pattern, 49
 Door seals, 51
 Door skirts, 50
 Main brush adjustment knob, 13
 Rear skirts, 50
 Side brush adjustment knob, 13
 Side brush dust control skirts, 51
 Side brush guard, 49
 Side brush pivot, 49

C

Capacities, 56
 Chains, 42
 Charging system light, 14
 Circuit breakers, 41
 Cleaning the hopper dust filter, 44
 Cleaning the Dust Filter, 44
 Clogged hydraulic filter light, 14
 Control panel
 Battery discharge indicator, 15
 Charging Sytem light, 14
 Clogged hydraulic filter light, 14
 Hopper door closed light, 14
 Hopper temperature light, 14
 Operating/hazard lights switch, 15
 Parking brake light, 12
 Controls
 Battery discharge indicator, 15
 Charging system light, 14
 Circuit breakers, 41
 Clogged hydraulic filter light, 14
 Fuse, 40
 Hopper door closed light, 14
 Hopper temperature light, 14
 Main brush adjustment knob, 13
 Main cover lever, 13
 Operating/hazard lights switch, 15
 Parking brake light, 12
 Power kill switch, 15
 Relay, 40
 side brush adjustment knob, 13
 Steering wheel tilt handle, 13
 Controls and Instruments, 8
 Cyclone cover seals, 45
 Cyclone dust tray seals, 44
 Cyclone perma-filter, 45

D

Deluxe suspension seat, 16
 Dimensions, 56
 Directional pedal, 12
 Disengaging hopper support bar, 27 – 29
 Doors
 Brush
 Seals, 51
 Skirts, 50
 Hopper, Seals, 52
 Hopper access, Seal, 51, 52

E

Electric motors, 41, 57
Electrical
 Circuit breakers, 41
 Fuse, 40
 Relay, 40
Electrical system
 Batteries, 37
 Checking connections / cleaning, 37
 Checking the electrolyte level, 37
 Charging batteries (off-board charger), 38
Emptying the hopper, 24 – 26
Engaging hopper support bar, 26 – 28

F

Filter Chamber Inlet Seal, 52
Filters
 Cleaning the Dust Filter, 44
 Cleaning the hopper dust filter, 44
 Cyclone perma-filter, 45
Front Wheel Bearings, 34
Fuses, 40
Fuses, relays, and circuitbreakers, Electric, 40

G

General Machine Dimensions / Capacities, 56
Grease fittings
 Hopper lift arm pivots, 35
 Rear wheel support, 34
 Steering link, 34

H

Hopper
 Access door seal, 51, 52
 Disengaging hopper support bar, 27 – 29
 Door closed, Light, 14
 Door seals, 52
 Dust filter, 43 – 45
 Emptying the hopper, 24 – 26
 Engaging hopper support bar, 26 – 28
 Lift arm pivots, 35
 Lip skirt, 50
 Replacing dust filter, 43 – 45
 Seals, 51
 Side skirt, 50
 Temperature, Light, 14
 Thermo-Sentry, 14

Hopper access door seal, 51, 52
Hopper door closed light, 14
Hopper door seals, 52
Hopper dust filter, 43 – 45
Hopper dust filter cover seal, 45
Hopper lift arm pivots, 35
Hopper lip skirt, 50
Hopper seals, 51
Hopper side skirt, 50
Hopper temperature light, 14
Hour Meter, 15
How the Machine Works, 17
Hydraulic fluid, 36
Hydraulic fluid reservoir, 35
Hydraulic Hoses, 36
Hydraulic pump belt, 42
Hydraulics, 35
 Check the hydraulic hoses, 36
 Clogged hydraulic filter light, 14
 Fluid, 36 – 38
 Hydraulic Hoses, 36
 Hydraulic pump belt, 42
 Reservoir, 35
 System specifications, 57

I

Indicators
 Battery discharge, 11
 Hour Meter, 15
Installing Batteries, 11

J

Jack points, 55
Jacking up the machine, 55

K

Knobs
 Main brush adjustment, 13
 Right side brush adjustment, 13

L

Levers

- Main cover, 13
- Steering wheel tilt handle, 13

Lights

- Charging system, 14
- Clogged hydraulic filter light, 14
- Hopper door closed, 14
- Hopper temperature, 14
- Operating/hazard lights switch, 15
- Parking brake, 12

Lubrication, 34

- Front Wheel Bearings, 34

M

Machine components, 7

Machine Dimensions, 58

Machine jacking, 55

Machine Operation, Pre—Operation Checklist, 19

Machine Specifications, 56 – 59

Machine tie down location, 54

Machine Troubleshooting, 31

Main brush

- adjustment, 13
- Belt, 42
- Checking brush pattern, 47 – 49
- Door seals, 51
- Door skirts, 50
- Intermediate belt, 42
- Rear skirts, 50

Main brush adjustment knob, 13

Main brush belt, 42

Main brush intermediate belt, 42

Main Brushes, 46

- Adjusting the Taper, 47
- Adjusting the Width, 48
- Replacing or Rotating the Main Brushes, 46

Main Brushes, Adjusting the Taper, 47

Main Brushes, Adjusting the Width, 48

Main Brushes, Replacing or Rotating, 46

Main cover, Lever, 13

Main cover lever, 13

Maintenance, 32 – 56

- Batteries, 37
 - Checking connections / cleaning, 37
 - Checking the electrolyte level, 37
- Charging batteries (off-board charger), 38

Maintenance Chart, 32

Motors, Electric, 41, 57

O

Operating temperature, 18

Operating/hazard lights switch, 15

Operation, 7 – 31

Operation of controls, 12

Operator seat, 16

Options, 29 – 31

- Hopper door closed light, 14
- Operating/hazard lights switch, 15
- Power kill, 15
- Side brush dust control skirts, 51
- Tower bumpers, 30
- Vacuum Wand, 29

P

Parking brake light, 12

Parking brake pedal, 12

Pedals

- Brake pedal, 12
- Directional pedal, 12
- Parking brake pedal, 12

Pivots

- Hopper lift arm, 35
- Side brush, 49

Power kill switch, 15

Pre—Operation Checklist, 19

Propelling gearbox, 34

Pushing or Towing the Machine, 54

Pushing the Machine, 54

Pushing, Towing, and Transporting the Machine, 54

- Pushing or Towing the Machine, 54
- Transporting the Machine, 54

R

Rear skirts, 50

Rear wheel

- Steering link, 34
- Support, 34

Rear wheel support, 34

- Bearings, 34
- Grease fitting, 34

Rear Wheel, Torque, 53

Relays, 40

Replacing or Rotating the Main Brushes, 46

Replacing the hopper dust filter, 43 – 45

Replacing the Side Brush, 48

S

Safety

Disengaging hopper support bar, 27 – 29

Engaging hopper support bar, 26 – 28

Labels, 5 – 7

Precautions, 3 – 5

Seals, 50 – 53

Brush doors, 51

Cyclone cover seals, 45

Cyclone dust tray seals, 44

Filter Chamber Inlet Seal, 52

Hopper, 51

Hopper access door, 51, 52

Hopper door, 52

Hopper dust filter cover seal, 45

Seat

Adjustment, 16

Deluxe suspension, 16

Seat belts, 16

Seat, Operator, 16

Side brush, 48

Adjust the pattern, 49

adjustment, 13

Dust control skirts, 51

Guard, 49

Pivot, 49

Replacing the Side Brush, 48

Side brush down pressure knob, 13

Side brush dust control skirts, 51

Side brush guard, 49

Side brush pivot, 49

Side Brush, Adjusting, 49

Side Brush, Replacing, 48

Side brush(es), Checking brush pattern, 49

Skirts, 50 – 53

Brush doors, 50

Hopper Lip, 50

Hopper side, 50

Rear, 50

Side brush dust control, 51

Specifications, 56 – 59

Braking system, 58

Chargers, 57

Electric motors, 57

General Machine Dimensions / Capacities, 56 – 59

Hydraulic system, 57

Machine Capacities, 56

Machine Dimensions, 56

Machine performance, 57

Power type, 57

Steering, 57

Tires, 58

Starting the machine, 20

Steering, Specifications, 57

Steering link, 34

Grease fitting, 34

Steering wheel tilt handle, 13

Stop sweeping, 23

Storage Information, 55

Storing the Machine, 55

Sweeping, 22 – 24

Switches

Operating/hazard lights, 15

Power kill, 15

Symbol definitions, 9 – 11

T

Temperature, Operating, 18

Thermo—Sentry, 14

Tie down location, 54

Tires, 53

Specifications, 58

Tower bumpers (Option), 30

Towing the Machine, 54

Transporting the Machine, 54

Travel speed, 57

Turning off the machine, 21 – 23

V

Vacuum fan, Belt, 42

Vacuum fan belt, 42

Vacuum Wand, 29

W

Wheels, 53

While operating the machine, 18